



Eurotec[®]

**DECK- & GARDEN-
PROGRAMME 2020**

More than

20

YEARS
of quality

The innovative fastening systems for modern deck construction in gardens, parks and green spaces.





Deck construction and landscaping

Terrace handling instructions	4 - 7
Selecting screw steels based on their corrosion resistance	8
Overview of timber types	10 - 16
Information about our service	18 - 21
Accessories for decking substructures	22 - 25
Eurotec Stone System	26 - 27
Eurotec adjustable pedestals	28 - 33
Aids for installing stone slabs	34 - 37
Robusto deck pedestal	38 - 39
Eurotec aluminium profiles	40 - 59
Edge joints	60 - 71
Hidden fastening accessories	72 - 84
Visible fastening accessories	85 - 88
Screws for terrace construction	89 - 99
Aids for laying decking boards	100 - 106
Accessories for wooden façades	107 - 111
Wood connectors and fittings	112 - 121
Eurotec sales shelves	122 - 125
Conditions of sale and delivery	126
Index	127

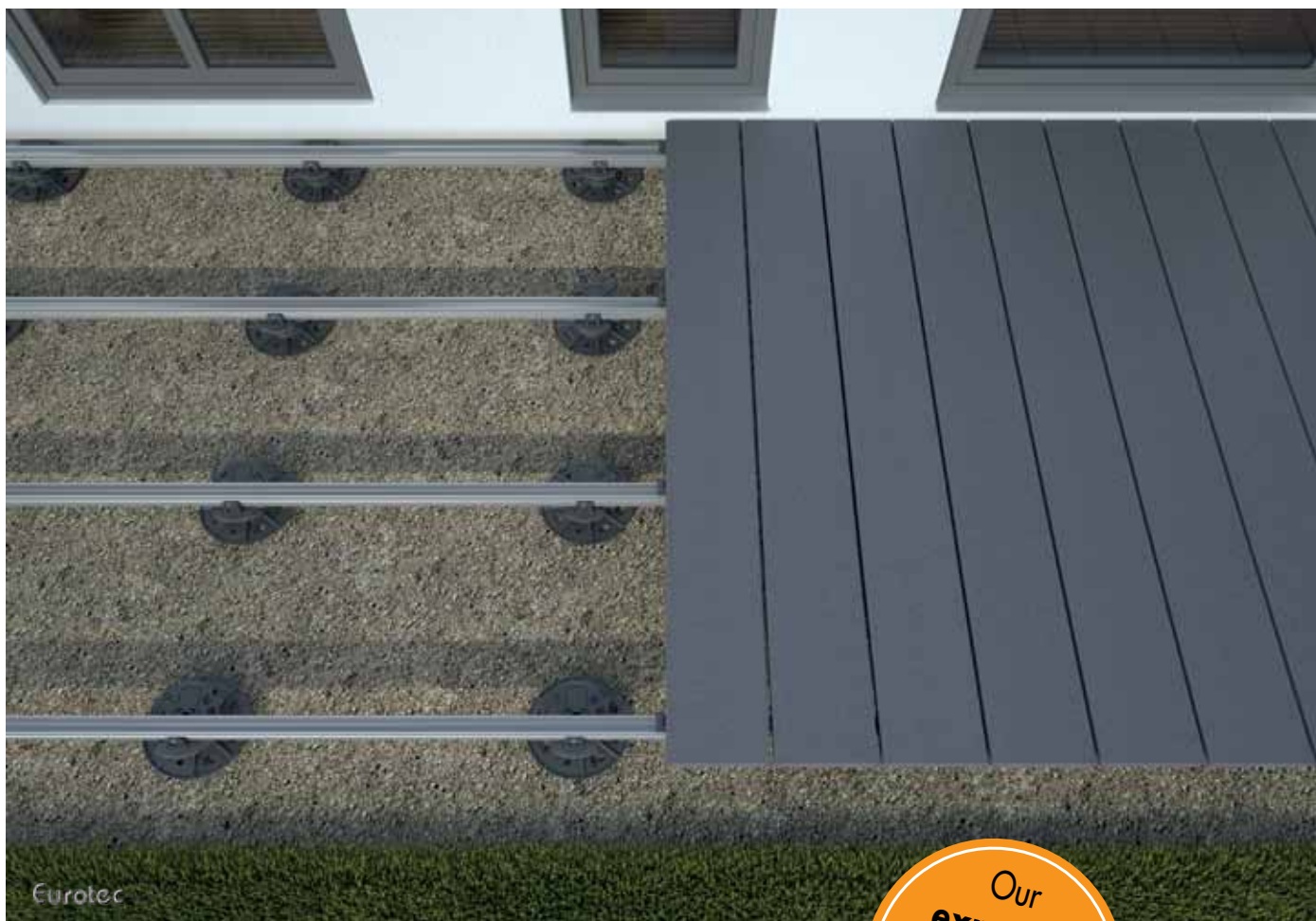

Proper surface for adjustable pedestals

If you want to build/create a viable and permanently reliable terrace, the condition of the subsurface significantly contributes to the success of the project and should therefore be prepared carefully in advance.

If no foundations are available, we recommend to use adjustable pedestals. For a properly designed terrace construction, a load-bearing substrate made of gravel, split or floor slabs is required. These can absorb arising loads in the soil.

Before the substructure made of aluminium profiles or support beams are laid.

- A supporting structure is required. Appropriate preparations must be made for loose subsurface.
- Stake out the planned area and remove any natural soil, such as turf, rocks and weeds.
- Remove the top layer of soil that contains humus and soil-dwelling organisms in addition to inorganic substances.
- If the topsoil is removed, dig out a 20 - 30 cm deep bed. Fill with crushed gravel or chippings and compact each layer separately to ensure a stable substrate.
- Here, too, a gradient of 1 - 2% to the garden should be considered.

- Pure sands and gravels are not recommended as they are not based on the displacement of the individual grains.
- Lay concrete slabs of approx. 30 x 30 cm at the same distance as the foundation.
- If there is risk of impact vibration on the decking, the decking pedestals should be secured in place. In addition, decking pedestals that are frequently subject to stresses should be secured by screws to avoid twisting.

Please note that the mentioned processing instructions are only recommendations and are not binding installation instructions.

Each assembly has different requirements, for which the executing company is responsible.

In order to determine the strength of the superstructure, it is important to determine the expected load on the terrace. Thus, paths with no vehicle traffic do not require a supporting layer, or you can choose to use one with a very low strength (10 - 20 cm). Stronger layers are required for busy paths.

First, the area is measured in the terrain (position, slope) and marked. Work is carried out on each of the sides, approx. 10 cm beyond the width of the deck to stabilise the surface edges. Good topsoil can be stored on heaps for further use on the planting areas or removed with the entire excavation work.

Planum

After digging, the subsurface (soil, natural ground) is levelled out, possibly improved (stabilised) and compacted. The flatness of the substructure is necessary to prevent the collection of water in uneven and sinking ground, which can later lead to lowering of the superstructure.

• Example for the improvement of the substrate

Too higher water content compensated by coarse gravel or burnt lime, in case of unfavourable grain composition (e.g. gravel 8/16, 16/32) incorporate missing grain sizes can be.

Frost protection layer

If necessary, an antifreeze layer can be installed, which consists of gravel-sand or grit-sand mixtures of grain size 0/32 and should have a minimum thickness of 10 cm. After installation, the compacting of the layer takes place. At the same time, it also serves as a granular subbase, which prevents indentations of the base layer in the substructure.

Base layer

This is followed by the installation of the base layer.

- Absorption and distribution of the traffic load
- Material: Mineral gravel or recycled material with grit sizes 0/32, 0/45, 0/56. No zero-components if enhanced water permeability **mineral concrete** is required, e.g. under a mosaic pavement or plate coverings under a heavy load

The thickness of the base layer depends on the expected load. After the gravel has been installed (compression factor 1.3), this is levelled, first a rough plan with the spade is made, followed by a fine planum with a rake.

In this case, slopes (generally, 2% is sufficient) are observed. For terraces with garden access, the water can usually be led into the neighbouring beds, depending on the width of the path, a roof slope can be planned. Longitudinal gradients mostly result from the conditions of the terrain. For thicker layers, the compaction takes place layer by layer every 20 - 25 cm. In order to prevent the gravel from separating, it is installed and compacted when it is moist.



Processing instructions Terrace

Substructure

A properly executed substructure is of great importance for a stable and durable wooden terrace. On the one hand, it has the task of supporting the actual decking, so that a flat surface is maintained even under a heavy load. On the other hand, it serves as the constructive protection of wood by creating a distance between the ground and decking/wooden supports. The wood is thus neither exposed to waterlogging or increased wood moisture in the ground-air zone.

Waterlogging and increased moisture content coupled with the use of unsuitable wood species would create a breeding ground for wood-destroying organisms.

In the following, we would like to show you various approaches to the construction of a terrace substructure.

A supporting ground is required. This can be compacted soil or gravel as mentioned before. This is where the foundation rests on. The support timbers are laid on these.

The foundations create the above mentioned necessary distance between soil and wood and remove the emerging loads.



Here are three examples for the installation of substructures

- 1 A strip foundation is poured into concrete. This is very expensive and requires very accurate work.



- 2 Concrete elements are laid in a gravel bed. These are relatively difficult to transport and position.

In the versions 1. and 2. a problem becomes clear: You have to work very precisely to bring the top edges of the foundations to exactly the same height. Since this is usually not possible, the supporting joints must be later relined.

The **Rolfi spacers** (p. 24 - 25) are particularly suitable for this.



- 3 **Adjustable pedestals by Eurotec**
The adjustable pedestals can be placed directly on compacted ground or on concrete. The time-consuming construction of the foundations and the relining of the substructure wood for height adjustment. The height can be infinitely adjusted together with the supporting joint, which is connected by a bracket directly to the adjustable pedestal.



© NATURinFORM

Expert hints

Hazards in the construction of timber decks

The various timber types differ from one another not only in their appearance but also in their technical properties:

- One particularly important property of wood with regard to deck construction is dimensional stability (also known as "resilience"). Experts use this term to refer to the property whereby wood changes shape in the course of use due to swelling or shrinkage. The various timber types show different degrees of dimensional stability. For this reason, special attention must be paid to the choice of the timber type. For deck construction, we recommend using timber with high dimensional stability. Some timber types, including Massaranduba, exhibit lower-than-average dimensional stability, so we explicitly advise against using these timber types for deck construction. Since, from an absolute perspective, the swelling and shrinkage behaviour increases as the width of the timber boards increases, we also recommend a maximum board width of 120 mm. You can find details of the dimensional stability of some common timber types in the "Overview of timber types" on p. 10 - 16 of our catalogue.
- Rift-sawn planks should always be used in preference to flat-sawn planks, as they have considerably better properties with respect to cracking, splintering, swelling and shrinkage, as well as dimensional stability, and therefore tend to distort and warp less. Often, so-called flat-sawn planks cannot be fastened permanently with either visible or hidden methods. In such cases, we cannot guarantee permanent fastening.
- Even fine particles of abraded metal can lead to dark spots of corrosion on the timber boards. Metalwork should not therefore be carried out in the direct proximity of the deck.
- Constituent substances in the timber can cause contamination of adjacent surfaces; it is therefore important to take constructive precautions, such as maintaining sufficient distances from nearby components.
- As nature does not adhere to quality guidelines, the suitability of timber for deck construction does not depend solely on the timber type. Often, problems can occur even due to individual batches of a timber type that is normally harmless. Possible reasons for this include spiral grain and insufficient drying.
 - Spiral grain refers to a wood grain that has grown in a spiral around the trunk axis; this becomes a problem if, in the course of use, the moisture contained in the wood deviates from the moisture level at installation. If this happens, internal tension in the wood is released and can therefore cause the

deck boards to warp. The energy released in this process is so enormous that it often impairs even perfectly installed fastening systems.

- It is a property of every timber to be able to absorb and emit water. For the user, this property can primarily be perceived through the timber's swelling and shrinking. One task of the timber trade is to bring timber to the correct state of dryness for the respective area of use. If timber is used that has an incorrect moisture content at installation, this can quickly lead to damage.
- Many properties of the timber vary strongly depending on the grade. It is therefore advisable to contractually stipulate all criteria in advance with your timber dealer!
- Particular care should be taken when purchasing Bangkirai. In the past, increased demand often meant that substitute timber from South East Asia was – knowingly or unknowingly – traded as Bangkirai. Most of these substitute timbers are considerably less suitable for deck construction. This results in cracking, strong warping and bending of the boards.
- It is essential to use identical timber types in order to ensure the durability of the deck – i.e. the upper deck and substructure must be made of the same material.
- **Application of bits made of stainless steel**

When setting screws, it inevitably always leads to a little abrasion between the screw drive and bit. This abrasion can lead to discolouration of the wood surface and the screw head in outdoor applications or in wet rooms, when attaching wood rich in tannins. Mistakenly, this is often attributed to the screw, even if it is made of stainless steel. In order to avoid the risk of discolouration due to extraneous rust, stainless steel bits should also be used for setting stainless steel screws!

A lot of damage to deck structures can be prevented in advance by thoroughly inspecting the timber that is to be installed. If, for example, the tradesman responsible already notices deformation in the deck boards before installation, none of these boards should be installed.

Selecting screw steels based on their corrosion resistance

Step by step

Select the right screw material for your project by observing the following principles. Go through the three points one after the other. The right material is marked for points 1 and 2 with (X) at least, or even better with X. In the event of additional chemical stress, point 3 must conform as well.

1. What's the component's situation? Is it exposed to the weather (fence) or is it protected (ceiling beam)?
2. Which wood is being fastened? Is it simple construction wood, or tannin-rich tropical wood?
3. Are there any additional stresses in situ that encourage corrosion? Location near the sea? Heavy industry, etc.?

Example: fastening a façade made of Douglas fir

1. Use class = 3, because exposed to weather. Façade = optical requirements. → at least C1
 2. Douglas fir → min. C1, but an A2 or A4 is to be preferred.
 3. This point is not required, because there are no further external stresses.
- Selection: C1 is possible, but A2 or A4 is to be preferred.

Steel group	Carbon steel		Stainless steel, martensite	Stainless steel, austenite	
	Electroplated	Special coating	C1; hardened stainless steel	A2	A4
Product examples	Panelwistec blue/yellow Hobotec blue/yellow	Panelwistec 1000 Topduo	Terrassotec stainless steel, hardened Hapatec	Terrassotec A2	Terrassotec A4 Hapatec Heli
1. Position of the component?					
NKL 1 ^{a)}	X	X	X	X	X
NKL 2 ^{a)}	X	X	X	X	X
NKL 3 ^{a)}	-	(X) ^{b)}	X	X	X
2. Which wood? ^{d)}					
Structural timber, wood materials ^{a)}	X	X	X	X	X
Beech (red beech)	X	X	X	X	X
Douglas fir	-	-	(X) ^{e)}	X	X
Spruce	X	X	X	X	X
Pine	X	X	X	X	X
Larch	-	-	(X) ^{e)}	X	X
Coniferous wood, pressure-impregnated	(X) ^{b)}	(X) ^{b)}	(X) ^{b)}	(X) ^{b)}	X
Red cedar	-	-	-	(X) ^{f)}	X
Fir	X	X	X	X	X
Thermotreated wood from coniferous wood	-	-	-	(X) ^{f)}	X
Abachi	-	-	-	(X) ^{f)}	X
Afzelia, doussié	-	-	-	(X) ^{f)}	X
Azobé, bongossi	-	-	-	-	X
Bangkirai, balau	-	-	(X) ^{e)}	X	X
Bilinga	-	-	-	(X) ^{f)}	X
Courbaril, jatobá	-	-	-	-	X
Cumarú	-	-	-	(X) ^{f)}	X
Sweet chestnut	-	-	-	-	X
Oak	-	-	-	-	X
Eukalyptus	-	-	-	-	X
Garapa	-	-	-	-	X
Ipé	-	-	(X) ^{e)}	X	X
Iroko	-	-	(X) ^{e)}	X	X
Itaúba	-	-	-	-	X
Kosipo	-	-	-	-	X
Massaranduba	-	-	-	-	X
Merbau	-	-	-	-	X
Robinie	-	-	-	-	X
Thermally modified timber made from hardwood	-	-	-	(X) ^{f)}	X
3. Additional chemical load?					
Constant condensation ^{g)}	-	-	-	(X) ^{b)}	X
Salt load ^{h)}	-	-	-	(X) ^{b)}	X
Aggressive atmospheres ^{k)}	-	-	-	-	(X) ^{m)}
Chlorous atmospheres ^{l)}	-	-	-	-	-

- a) Use classes in accordance with DIN EN 1995:2008. NKL 1 - components in structures enclosed on all sides, partly heated. NKL 2 - components in roofed, open structures without direct weather exposure. NKL 3 - freely weathered constructions.
- b) Recommended only for less significant fastening points, or for temporary objects, or if there are no visual requirements.
- c) Pilot-drilling and, where applicable, pre-countersinking, is recommended in general for hardwoods. This also applies for coniferous woods in deck and façade construction.
- d) Untreated: spruce, fir, pine, composite timber, KVH[®], veneering laminated wood, solid wood, etc., plywood, OSB, fibreboards, cement-bound and gypsum fibreboards, etc.
- e) In our experience, using this timber with C1 does not lead to problems with corrosion or timber discolouration. Depending on the origin of the timber, however, this cannot be ruled out completely. Please also inquire at your timber dealer.
- f) Use of A4 is recommended. Please contact your wood dealer as well.

- g) Uninterrupted condensation in a water vapour atmosphere with only slight impurities.
- h) Building components close to roads heavily affected by salting in winter, coastal areas, in offshore and other industrial installations.
- k) For example: building components in road tunnels, pig stalls or in other aggressive atmospheres, possibly with additional higher air humidity.
- l) Building components in indoor swimming pools or other chlorous atmospheres.
- m) Use to be checked in the individual case.

This overview cannot take account of all applications. Materials can be assigned to more unfavourable conditions as well in an individual case.

Wood decks

Because of constantly occurring problems with the use of hardwood/tropical woods we want to point out some fundamental working guidelines that must be observed. However, we refer in general to the recommendations of your wood dealer, because there can be extreme fluctuations in the wood properties with the same wood type, above all with tropical woods. Bangkirai wood, for example, which is often used, can have very different properties, because the properties depend heavily on the source in each case. If the variety of wood properties within a range is ignored, this can lead to various problems with regard to screws breaking off.

At a width of 140 mm, Bangkirai woods or other hardwood/tropical woods can swell or shrink by up to 7 mm, depending on the wood moisture. With direct screwing through the boards into the substructure we recommend using a pair of screws. If the board is fastened directly on the substructure and the board works from the centre by about 3,5 mm, this leads in some cases to the screws being sheared off. The hardwood/tropical wood does not allow the screw to absorb any movement because it can barely be compressed because of its own high density.

Although deck/wood construction screws today have a suitable deflection angle, hardwoods that are placed directly on top of each other function as shearing modules that shear the screws off if the wood swells or shrinks. (Per board half = 3,5 mm displacement, this conforms to about the inside diameter of a screw with a 5 mm thread, which is the minimum that should be used with tropical woods).

In certain circumstances, screwing in the centre of the board might be deducted from this. Unfortunately, tropical woods have an extremely high internal stress, which leads to the boards twisting (dishing), which in most cases requires pairs of screws.

However, using a spacer (e.g. Dista-Leiste 2.0 or deck glider) between the substructure and deck board is very helpful here. This provides the screws with a possibility of bending in the direction of the working wood. The danger of shearing is greatly reduced. In addition, this clearance protects the wood from waterlogging at the support points. The ageing process is slowed down clearly.

A mistake that is frequently made is to have centre distances in the substructure that are too large. The most durable results are achieved if this clearance, and therefore the screw clearance in the lengthwise direction of the boards, is max. 60 cm.

Please note that the installation information provided here is merely a recommendation and does not constitute binding assembly instructions. Every assembly job is subject to different performance requirements, e.g. locally applicable building regulations, and the tradesman carrying out the installation is responsible for compliance with these requirements.



Pilot-drilling is always better with problematic woods. These are above all hardwood/tropical woods, but also some coniferous woods that tend to crack easily, such as e.g. Douglas fir.

Pilot drilling prevents the wood splitting. With regard to the edge distances make sure that there is at least 6 cm clearance to the end of the board.

(Please note: because of the high internal stress the boards can also crack open later at the ends and in the middle. This also applies to thermally treated woods).

Overview of timber types*

*Solid wood decking is not part of our product range. This short overview represents a planning aid.

A timber deck matches any ambience. Whether they are left natural and greying or are treated with care products: They lend a certain proximity to nature or even a sense of urban chic, and always a sense of well-being.

As well as a suitable fastening system, above all good planning and professional assembly are essential for long-lasting, low-maintenance deck construction. Not all timber is the same: As well as aesthetics and price, it is advisable to weigh up the technological properties against one another. A timber with very high durability and an astoundingly beautiful exterior can, for example, have only moderate dimensional stability and may not be suited for indirect, hidden fastening. This overview of the most common deck timbers might assist you in your considerations.

Please ensure that you refer to the information we provide on "Hazards in the construction of timber decks" on page 7.



Glossary

- E-modulus (modulus of elasticity) – resistance of a material to elastic deformation. The higher the Young's modulus, the stiffer the component. This overview quotes the Young's modulus as measured parallel to the grain.
- Durability class – indication of the natural durability of the heartwood with respect to fungus, from 1 (very durable) to 5 (not durable).
- Dimensional stability – characteristic of the timber not to warp, twist, etc. due to swelling/shrinkage.

Thermo Pine (*Pinus sylvestris*)

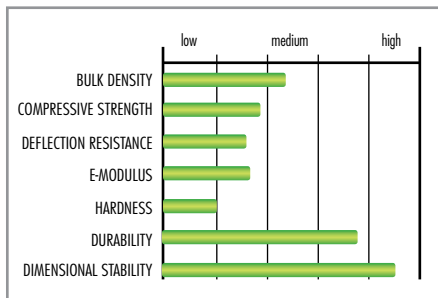

- + High durability
- + No resin leakage
- + Low swelling and shrinkage
- + Substitute for tropical timber
- + Excellent dimensional stability
- + Mostly obtained from sustainable forestry
- Surface made brittle by thermal treatment
- Not for structural applications
- Only moderate hardness

General details:

- **Origin:** Europe, east as far as Siberia
- **Colour:** Uniform brown to dark brown as a result of thermal treatment, also greying as untreated timber
- **Durability class:** 1–3 with thermal treatment (3–4 untreated)
- **Properties:** Low swelling and shrinkage, excellent dimensional stability. Thermal treatment leads to a reduction in strength and elasticity, causing the surface to become brittle. Contrast-rich texture.

Application:

Deck construction, sometimes as a substitute for tropical timber, not to be used for structural applications.

Installation instructions:

- Centre distance in substructure: max. 50 cm
- Joint width between boards: 6 to 8 mm
- Spacing between butt joints: 3 to 4 mm

Fastening recommendation:

Use Thermofix screw with drill point for the deck glider (brittle surface!). For direct fastening, use Terrasotec A4 5,5 mm, Hapatec Heli A4 5,0 mm or Profile drilling screw A4 5,5 mm for Eurotec aluminium profiles. It is always advisable to drill a pilot hole with a drill stop.



Robinia, False Acacia (*Robinia pseudoacacia*)

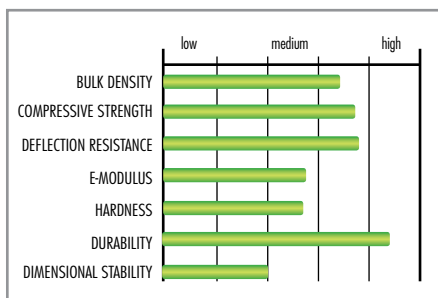

- + High durability
- + High strength
- + High hardness
- + Substitute for tropical timber
- + Largely sourced from sustainable forestry
- Moderate dimensional stability

General details:

- **Origin:** North America, also cultivated in Europe since the 17th century (not to be confused with Acacia)
- **Colour:** Yellow-green to olive brown, darkening to golden brown
- **Durability class:** 1–2, most-durable domestic timber
- **Properties:** High swelling and shrinkage, satisfactory to moderate dimensional stability, high strength and hardness, distinctive texture.

Application:

Deck construction, window frames, playground construction, fencing, excellent structural timber for outdoor use, sometimes used as a substitute for tropical timber.

Installation instructions:

- Centre distance in substructure: max. 60 cm
- Joint width between the boards: 6 to 10 mm
- Spacing between the butt joints: 3 to 4 mm

Fastening recommendation:

For timbers with high wood density and/or moderate dimensional stability, direct fastening of the boards is preferable to hidden. This applies above all to board thicknesses > 25 mm. For direct fastening, use Terrasotec A4 5,5 mm or Profile drilling screw A4 5,5 mm for Eurotec aluminium profiles. It is always advisable to drill a pilot hole with a drill stop.



Merbau (*Intsia spp.*)

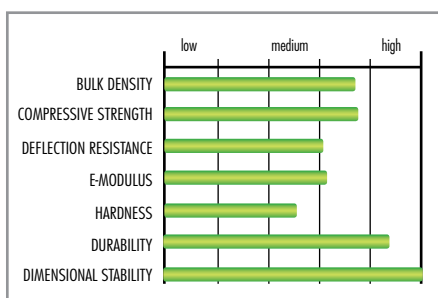

- + High durability
- + High strength
- + High hardness
- + Low swelling and shrinkage
- + Exceptionally good dimensional stability
- Possible erosion of constituent substances in the timber
- Originates almost exclusively from overexploitation (certified timber barely available)

General details:

- **Origin:** Southeast Asia, trade name encompasses various species
- **Colour:** Light brown to reddish brown, darkening to brown to dark copper brown
- **Durability class:** 1–2
- **Properties:** Very low swelling and shrinkage, excellent dimensional stability, high strength and hardness

Application:

Deck construction, window frames, parquet, stairs, furniture

Installation instructions:

- Centre distance in substructure: max. 60 cm
- Joint width between the boards: 4 to 6 mm
- Spacing between the butt joints: 3 to 4 mm

Fastening recommendation:

For direct fastening, use Terrasotec A4 5,5 mm or Profile drilling screw A4 5,5 mm for Eurotec aluminium profiles. It is always advisable to drill a pilot hole with a drill stop.



Massaranduba (*Manilkara spp.*)

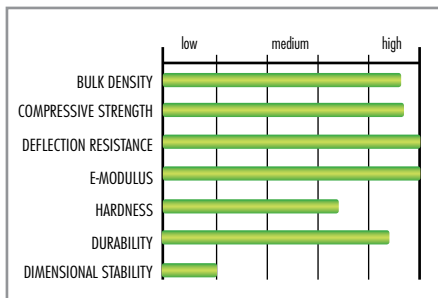

- + High durability
- + Extremely high strength
- + High hardness

- Extremely low dimensional stability
- Often originates from overexploitation (use only certified timber wherever possible)
- We consider permanent, secure fastening to be highly critical

General details:

- **Origin:** Northern to central South America, trade name encompasses various species
- **Colour:** Meaty red colour, later darkening to dark brown
- **Durability class:** 1-2
- **Properties:** High swelling and shrinkage, satisfactory to moderate dimensional stability, extremely high strength, high hardness, homogeneous texture.

Application:

Deck construction, floors subject to heavy loads, noise barriers and privacy screens, fencing, structural timber, sometimes used in water engineering.

Installation instructions:

The installation is extremely dependent on the timber's moisture level. The wood moisture must always be determined before installation. Ask your timber supplier for more information.

Fastening recommendation:

For timbers with high wood density and/or moderate dimensional stability, direct fastening of the boards is preferable to indirect. This applies above all to board thicknesses > 25 mm. For direct fastening, use Terrasotec A4 5,5 mm in combination with the Dista-Leiste 2.0 or profile drilling screw A4 5,5 mm for Eurotec aluminium profiles. It is always advisable to drill a pilot hole with a drill stop. Nevertheless, we cannot provide a general recommendation, as damage is repeatedly found to occur with this type of timber.



Kapur (*Dryobalanops spp.*)

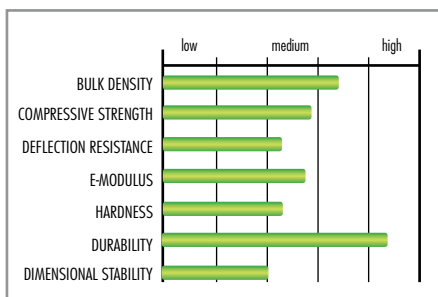

- + High durability

- Possible erosion of constituent substances in the timber
- Often originates from overexploitation (use only certified timber wherever possible)
- Moderate hardness
- Moderate dimensional stability

General details:

- **Origin:** Southeast Asia, trade name encompasses various species
- **Colour:** Orange to reddish brown, darkening to brown
- **Durability class:** 1-2
- **Properties:** Moderate to high swelling and shrinkage, satisfactory to moderate dimensional stability, homogeneous texture.

Application:

Deck construction, fencing, structural timber

Installation instructions:

- Centre distance in substructure: max. 60 cm
- Joint width between the boards: 6 to 10 mm
- Spacing between the butt joints: 3 to 4 mm

Fastening recommendation:

For timbers with high wood density and/or moderate dimensional stability, direct fastening of the boards is preferable to hidden. This applies above all to board thicknesses > 25 mm. For direct fastening, use Terrasotec A4 5,5 mm or Profile drilling screw A4 5,5 mm for Eurotec aluminium profiles. It is always advisable to drill a pilot hole with a drill stop.



Ipé, Lapacho (*Tabebuia spp.*)

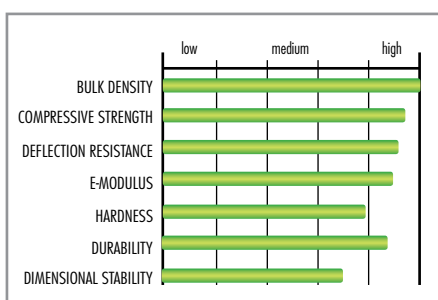

- + High durability
- + Good dimensional stability
- + Extremely high strength
- + Very high hardness
- + Approved structural timber

- Often originates from overexploitation (use only certified timber wherever possible)

General details:

- **Origin:** Northern to central South America, trade name encompasses various species
- **Colour:** Light brown to light yellowish brown, later darkening to brown to olive brown
- **Durability class:** 1-2
- **Properties:** Moderate to high swelling and shrinkage, good dimensional stability, extremely high strength, very high hardness, homogeneous texture.

Application:

Deck construction, bridge construction and shipbuilding, floating jetties, fencing, parquet, floors subject to heavy loads, approved structural timber, sometimes used in water engineering.

Installation instructions:

- Centre distance in substructure: max. 60 cm
- Joint width between the boards: 6 to 8 mm
- Spacing between the butt joints: 3 to 4 mm

Fastening recommendation:

For timbers with high wood density and/or moderate dimensional stability, direct fastening of the boards is preferable to hidden. This applies above all to board thicknesses > 25 mm. For direct fastening: Terrasotec, hardened stainless steel, 5,0 and 5,5 mm; Hapatec, hardened stainless steel, 5,0 mm; or Profile drilling screw, hardened stainless steel, 5,5 mm for Eurotec aluminium profiles. It is always advisable to drill a pilot hole with a drill stop.



Garapa (*Apuleia spp.*)

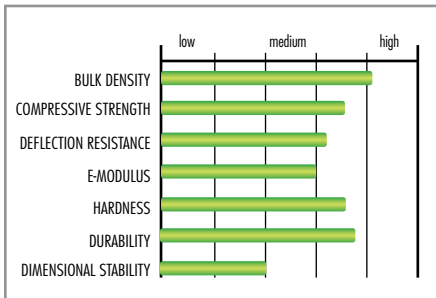

- + High durability (variable)
- + High strength
- + Very high hardness
- Possible erosion of constituent substances in the timber
- Often originates from overexploitation (use only certified timber wherever possible)
- Moderate dimensional stability

General details:

- Origin: South America, trade name encompasses various species
- Colour: Honey yellow, later darkening to yellowish brown or golden brown
- Durability class: Varies between 1 and 3
- Properties: Moderate to high swelling and shrinkage, satisfactory to moderate dimensional stability, plain, homogeneous texture.

Application:

Deck construction, furniture, window frames

Installation instructions:

- Centre distance in substructure: max. 60 cm
- Joint width between the boards: 6 to 10 mm
- Spacing between the butt joints: 3 to 4 mm

Fastening recommendation:

For timbers with high wood density and/or moderate dimensional stability, direct fastening of the boards is preferable to hidden. This applies above all to board thicknesses > 25 mm.

For direct fastening, use Terrasotec A4 5,5 mm or Profile drilling screw A4 5,5 mm for Eurotec aluminium profiles.

It is always advisable to drill a pilot hole with a drill stop.



Douglas Fir (*Pseudotsuga menziesii*)

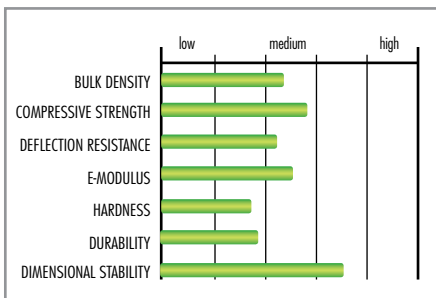

- + Low swelling and shrinkage
- + Good dimensional stability
- + Approved structural timber
- + Substitute for tropical timber
- + Largely sourced from sustainable forestry
- Resin bleed possible
- Moderate durability but sufficient for deck construction
- Moderate hardness

General details:

- Origin: North America, also cultivated in Europe since the 19th century
- Colour: Light yellowish brown to red brown, resembles European Larch.
- Durability class: 3-4
- Properties: High elasticity, low swelling and shrinkage, good dimensional stability, low resin content, fine texture.

Application:

Deck construction, façades, solid-wood floorboards, window frames, fencing, approved structural timber, sometimes used as a substitute for tropical timber.

Installation instructions:

- Centre distance in substructure: max. 60 cm
- Joint width between the boards: 6 to 8 mm
- Spacing between the butt joints: 3 to 4 mm

Fastening recommendation:

For direct fastening: Terrasotec, hardened stainless steel, 5,0 and 5,5 mm; Hapatec, hardened stainless steel, 5,0 mm; or Profile drilling screw, hardened stainless steel, 5,5 mm for Eurotec aluminium profiles.

It is always advisable to drill a pilot hole with a drill stop (risk of splintering).



Cumarú (*Dipteryx spp.*)

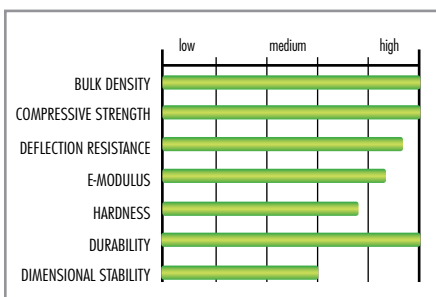

- + Very high durability
- + Extremely high strength
- + Very high hardness
- Possible erosion of constituent substances in the timber
- Often originates from overexploitation (use only certified timber wherever possible)
- Moderate dimensional stability

General details:

- Origin: Northern South America, trade name encompasses various species
- Colour: From yellowish to red to violet brown, later darkening to yellowish brown to olive brown
- Durability class: 1
- Properties: High swelling and shrinkage, good to satisfactory dimensional stability, extremely high strength, very high hardness, homogeneous texture.

Application:

Deck construction, floors subject to heavy loads, structural timber, sometimes used in water engineering.

Installation instructions:

- Centre distance in substructure: max. 60 cm
- Joint width between the boards: 6 to 8 mm
- Spacing between the butt joints: 3 to 4 mm

Fastening recommendation:

For timbers with high wood density and/or moderate dimensional stability, direct fastening of the boards is preferable to hidden. This applies above all to board thicknesses > 25 mm.

For direct fastening: Terrasotec A2 5,5 mm or Profile drilling screw A4 5,5 mm for Eurotec aluminium profiles.

It is always advisable to drill a pilot hole with a drill stop.



Bangkirai, Yellow Balau (*Shorea spp.*)

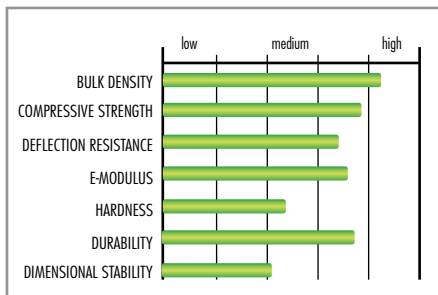

+ High durability
+ High strength
+ High hardness

- Possible erosion of constituent substances in the timber
- Often originates from overexploitation (use only certified timber wherever possible)

General details:

- **Origin:** South, Southeast and East Asia, trade name encompasses various species
- **Colour:** Yellowish brown, often darkening to olive brown
- **Durability class:** 2
- **Properties:** Medium to high swelling and shrinkage, satisfactory dimensional stability, high strength and hardness, distinctive texture.

Application:

Deck construction, piers, floating jetties, fencing, stables, flooring subject to heavy use, structural timber in water engineering. Many of the *Shorea* species of the Meranti group are used for window frames.

Installation instructions:

Installation is extremely dependent on the timber's moisture level. The wood moisture must always be determined before installation. Ask your timber supplier for more information.

Fastening recommendation:

For timbers with high wood density and/or moderate dimensional stability, direct fastening of the boards is preferable to hidden. This applies above all to board thicknesses > 25 mm. For direct fastening: Terrasotec, hardened stainless steel, 5,0 and 5,5 mm; Hapatec, hardened stainless steel, 5,0 mm; or Profile drilling screw, hardened stainless steel, 5,5 mm for Eurotec aluminium profiles. It is always advisable to drill a pilot hole with a drill stop.



Oak (*Quercus robur*, *Quercus petraea*)

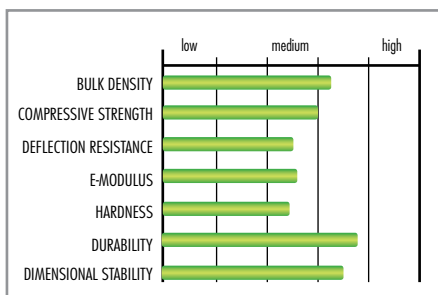

+ High durability
+ Good dimensional stability
+ High hardness
+ Approved structural timber
+ Substitute for tropical timber
+ Largely sourced from sustainable forestry

General details:

- **Origin:** Europe
- **Colour:** Yellow brown, darkening to brown to olive brown
- **Durability class:** 2
- **Properties:** Low swelling and shrinkage, good dimensional stability; distinctive, decorative texture.

Application:

Deck construction, stairs, parquet, furniture, window frames, fencing, approved structural timber, sometimes used as a substitute for tropical timber.

Installation instructions:

- Centre distance in substructure: max. 60 cm
- Joint width between the boards: 6 to 8 mm
- Spacing between the butt joints: 3 to 4 mm

Fastening recommendation:

For direct fastening, use Terrasotec A4 5,5 mm or Profile drilling screw A4 5,5 mm for Eurotec aluminium profiles. It is always advisable to drill a pilot hole with a drill stop.



Walaba (*Eperua spp.*)

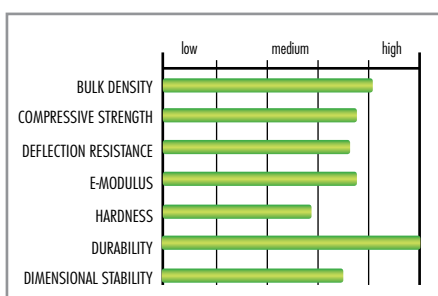

+ Very high durability
+ No erosion
+ Low swelling and shrinkage
+ Good dimensional stability
+ High strength and hardness
+ Timber from reservoirs means no destruction of primeval forest

General details:

- **Origin:** As reservoir timber from the Brokopondo Reservoir in Suriname (South America), otherwise from northern South America; trade name encompasses various species.
- **Colour:** Red brown to dark brown
- **Durability class:** 1
- **Properties:** As reservoir timber: low swelling and shrinkage, good dimensional stability, high strength and hardness, very decorative.

Application:

Deck construction, water engineering, fencing, piles, masts, structural timber.

Installation instructions:

- Centre distance in substructure: max. 60 cm
- Joint width between the boards: 6 to 8 mm
- Spacing between the butt joints: 3 to 4 mm

Fastening recommendation:

For direct fastening, use Terrasotec A4 5,5 mm or Profile drilling screw A4 5,5 mm for Eurotec aluminium profiles. It is always advisable to drill a pilot hole with a drill stop.



Siberian Larch (*Larix sibirica*)

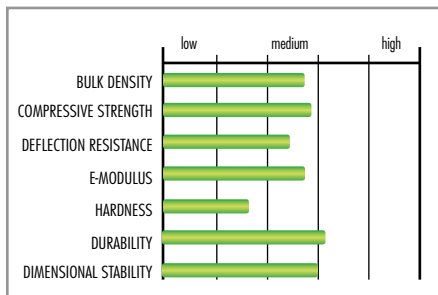

- + Low swelling and shrinkage
- + Predominantly knot-free
- + Approved structural timber
- Resin bleed possible
- Often originates from overexploitation, so questionable as a substitute for tropical timber (use only certified timber wherever possible)
- Moderate hardness

General details:

- Origin: Western and Southern Siberia, Mongolia
- Colour: Yellowish (European Larch: yellowish to reddish-brown)
- Durability class: Varies from 1 to 4 depending on where it is grown
- Properties: Very narrow rings, giving it a high wood density for softwood, high elasticity, low swelling and shrinkage, good to satisfactory dimensional stability, predominantly knot-free, low resin content, straight-grained texture.

Application:

Deck construction, façades, solid-wood floorboards, window frames, fencing, approved structural timber.

Installation instructions:

- Centre distance in substructure: max. 60 cm
- Joint width between the boards: 6 to 8 mm
- Spacing between the butt joints: 3 to 4 mm

Fastening recommendation:

For direct fastening: Terrasotec, hardened stainless steel, 5,0 and 5,5 mm; Hapotec, hardened stainless steel, 5,0 mm; or Profile drilling screw, hardened stainless steel, 5,5 mm for Eurotec aluminium profiles.
Pilot-drilling with drill stop recommended.



Thermo Ash (*Fraxinus spp.*)

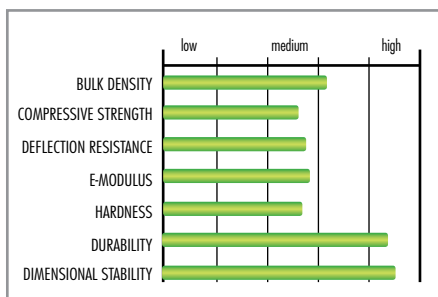

- + High durability
- + No erosion
- + Low swelling and shrinkage
- + Very good dimensional stability
- + Substitute for tropical timber
- + Largely sourced from sustainable forestry
- Surface made brittle by thermal treatment
- Not for structural applications
- Moderate hardness

General details:

- Origin: Central and Eastern Europe, North America
- Colour: Dark brown; also greying as untreated timber
- Durability class: 1-2; untreated: 5
- Properties: Low swelling and shrinkage, excellent dimensional stability, thermal treatment leads to reduction in strength and elasticity and causes the surface to become brittle.

Application:

Deck construction, parquet, floors, garden furniture, sometimes as a substitute for tropical timber, not to be used for structural applications.

Installation instructions:

- Centre distance in substructure: max. 50 cm
- Joint width between the boards: 4 to 6 mm
- Spacing between the butt joints: 3 to 4 mm

Fastening recommendation:

Use Thermofix screw with drill point for the deck glider (brittle surface!).
For direct fastening, use Terrasotec A4 5,5 mm or Profile drilling screw A4 5,5 mm for Eurotec aluminium profiles.
It is always advisable to drill a pilot hole with a drill stop.

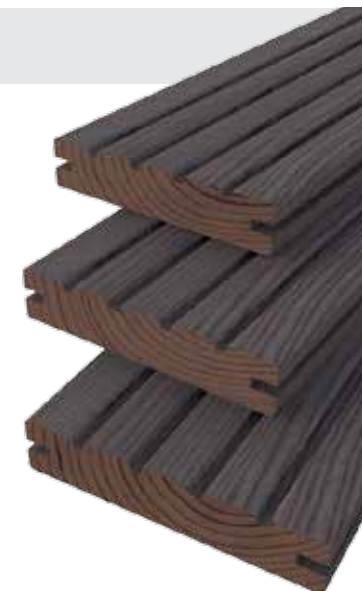

Thermo-Beech (*Fagus sylvatica*)

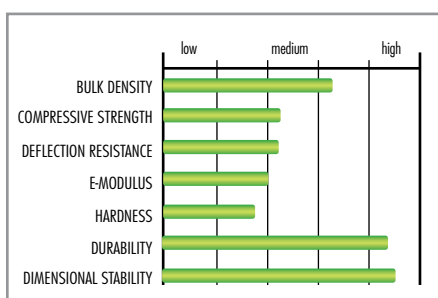

- + High durability
- + No erosion
- + Low swelling and shrinkage
- + Very good dimensional stability
- + Substitute for tropical timber
- + Largely sourced from sustainable forestry
- Surface made brittle by thermal treatment
- Not for structural applications
- Moderate hardness

General details:

- Origin: Central and South-Eastern Europe
- Colour: Dark brown; also greying as untreated timber
- Durability class: 1-2; untreated: 5
- Properties: Low swelling and shrinkage, excellent dimensional stability, thermal treatment causes reduction in strength and elasticity and makes the surface brittle, plain texture.

Application:

Deck construction, parquet, floors, worktops, sometimes as a substitute for tropical timber, not to be used for structural applications.

Installation instructions:

- Centre distance in substructure: max. 40 cm
- Joint width between the boards: 6 to 8 mm
- Spacing between the butt joints: 3 to 4 mm

Fastening recommendation:

Use Thermofix screw with drill point for the deck glider (brittle surface!).
For direct fastening, use Terrasotec A4 5,5 mm or Profile drilling screw A4 5,5 mm for Eurotec aluminium profiles.
It is always advisable to drill a pilot hole with a drill stop.



Courbaril, Jatobá (*Hymenea spp.*)

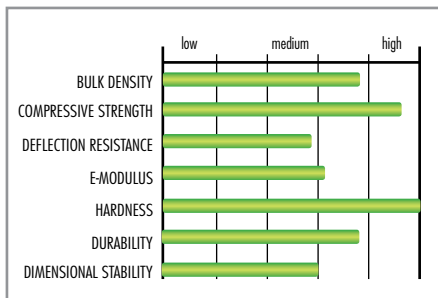

- + High durability
- + No washing out
- + Extremely high strength
- + Extremely high hardness

- Only moderate dimensional stability
- Often originates from overexploitation (use only certified timber wherever possible)

General details:

- **Origin:** Central and South America
- **Colour:** Trade name encompasses various species, usually salmon-coloured to yellowish brown, often later darkening to orange-brown to copper-coloured.
- **Durability class:** 1-3
- **Properties:** High swelling and shrinkage, good to satisfactory dimensional stability, high strength, extremely high hardness, very decorative.

Application:

Deck construction, solid wood floorboards, heavy-duty flooring, furniture, structural timber.

Installation instructions:

- Centre distance in substructure: max. 60 cm
- Joint width between boards: 6 to 8 mm
- Spacing between butt joints: 3 to 4 mm

Fastening recommendation:

For timbers with high wood density and/or moderate dimensional stability, direct fastening of the boards is preferable to indirect. This particularly applies to board thicknesses > 25 mm.
For direct fastening, use Terrasotec A4 5,5 mm, Hapatec Heli A4 5,0 mm or Profile drilling screw A4 5,5 mm for Eurotec aluminium profiles. It is always advisable to drill a pilot hole with a drill stop.



Acetylated wood (*Various types of timber*)

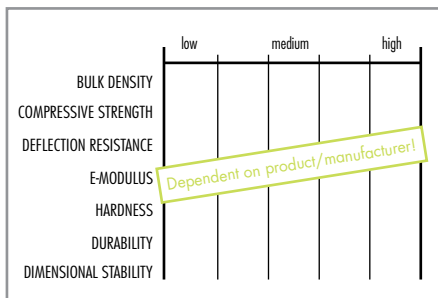

- + High durability
- + Very low swelling and shrinkage
- + Exceptionally good dimensional stability
- + Substitute for tropical timber
- + Mostly obtained from sustainable forestry

- Surface brittleness due to modification
- Not for structural applications
- Only moderate hardness

General details:

- **Origin:** Various countries of origin
- **Colour:** Depending on type of timber used
- **Durability class:** 1 (3-4 untreated)
- **Properties:** Very low swelling and shrinkage, exceptionally good dimensional stability. Possible brittleness due to modification with resulting increase in hardness and reduction of the timber's equilibrium moisture content.

Application:

Deck construction, façades, window frames, sometimes as a substitute for tropical timber, not to be used for structural applications.

Installation instructions:

- Centre distance in substructure: max. 60 cm
- Joint width between boards: 4 to 6 mm
- Spacing between butt joints: 3 to 4 mm

Fastening recommendation:

Use Thermofix screw with drill point for the deck glider (brittle surface).
For direct fastening, use Terrasotec A4 5,5 mm, Hapatec Heli A4 5,0 mm or Profile drilling screw A4 5,5 mm for Eurotec aluminium profiles.
It is always advisable to drill a pilot hole with a drill stop.



WPC (*Wood-Plastic-Composite*)

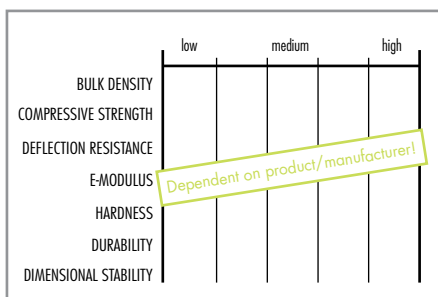

- + Good dimensional stability
- + Barefoot board
- + No erosion
- + Substitute for tropical timber
- + Largely sourced from sustainable forestry

General details:

Depending on the product in question, wood-plastic composite materials consist of different proportions of wood, plastics and additives. The wood content varies from 50% to 70%.
The natural fibres incorporated into the material originate predominantly from sustainable forestry. The properties of these polymer-bound products are equivalent to those of high-quality timber-based materials.

Application:

Deck construction, fencing, garden furniture, façades, edge profiles, privacy screen elements, sometimes used as a substitute for tropical timber.

Installation instructions:

Substructure spacing and joint width according to manufacturer's information.

Fastening recommendation:

WPC boards are usually fastened hidden and invisibly with clips, e.g. T-Stick on aluminium substructure.







We are happy to advise you on your construction projects

Contact our technical department or use the free calculation software in the service area on our homepage:

www.eurotec.team



Calculations/planning in the terrace area

- Quantity surveys and product recommendations for the construction of terraces
- Planning of special terraces, e.g. elevated terraces
- Installation diagram of terraces if necessary after placing an order
- Customised product developments for terrace construction

Calculations/planning in the field of timber construction

- On-rafter insulation with Paneltwistec and Topduo
- Main/secondary Beam connections with KonstruX, Atlas, Magnus and IdeeFix
- Geometric/joist doubling panels with KonstruX, Paneltwistec and Topduo
- Support reinforcements with KonstruX
- Rafter/purlin joints with KonstruX, Paneltwistec and Topduo

Calculations/planning in the area of concrete

- Fasteners in/on concrete components with rock concrete screw, bolt anchor and injection anchor

Calculations/planning in the façade area

- Quantity determinations for fixing facades and façade elements with EiSYS façade screws, Klimax insulation dowels, ERD frame dowels, Topduo and Paneltwistec

All data are planning/design aids and if necessary should be checked by a specialist planner!

Your contact person can be reached by

E-Mail: technik@eurotec.team

Tel: 02331 - 62 45-444

by phone 02331 6245-444 · by fax 02331 6245-200 · by e-mail technik@eurotec.team

Please contact our technical department or use the free [calculation services](#) in the service section of our website.

Contact

Trader:	_____	Contractor:	_____
Contact person:	_____	Contact person:	_____
e-mail:	_____	Phone:	_____
Project:	_____	e-mail:	_____

Project details

Utilisation

(to determine the loading capacity)

- | | | |
|---|---|---------------------------------|
| <input type="checkbox"/> private
(close to ground level) | <input type="checkbox"/> private
(Roof terraces, balconies, loggias) | <input type="checkbox"/> public |
| <input type="checkbox"/> Visible fastening | <input type="checkbox"/> Hidden fastening | |

Length Side A: _____ m
(running in direction of the substructure)

Length Side B: _____ m
(running in direction of the boards)

Centre distance e: _____ m
(substructure spacing)

Total assembly height from _____ to _____ mm
(Top edge of ground/finished floor/roof ↔ Top edge of board)

Nivello 2.0 required: Yes No
(to compensate a sloped subsurface)

Dimensions of decking boards: _____ mm
(Strength x width)

Boards grooved: Yes No
(if yes, please enclose a sketch showing groove)

Type of wood: _____

Timber substructure

Dimensions of joist: _____ mm
(Length x width)

Timber type of joist: _____

Deck edging end profile: Yes No

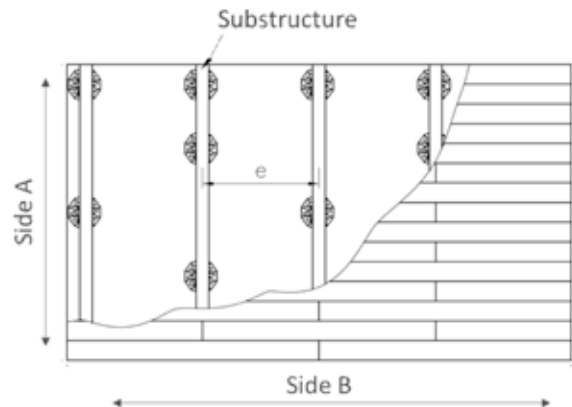

- | | |
|---|--|
| <input type="checkbox"/> System profile EVO Light
34 x 32 x 4000 mm
W x H x L | <input type="checkbox"/> Support profile HKP
60 x 100 x 4000 mm
W x H x L |
| <input type="checkbox"/> System profile EVO
60 x 40 x 4000 mm
W x H x L | <input type="checkbox"/> System profile EVO Slim
60 x 20 x 4000 mm
W x H x L |

*e.g. in connection with Systemclip ECO

by phone 02331 6245-444 · by fax 02331 6245-200 · by e-mail technik@eurotec.team

Please contact our technical department or use the free calculation services in the service section of our website.

Contact

Trader: _____

Contractor: _____

Contact person: _____

Contact person: _____

e-mail: _____

Phone: _____

Project: _____

e-mail: _____

Project details

Utilisation

(to determine the loading capacity)

- private (close to ground level)
- private (Roof terraces, balconies, loggias)
- public
- Corner support system (mounted on adjustable pedestals)
- Stone-System (mounted on aluminium profiles)

Length Side A: _____ m
(in stress direction of substructure = SS)

Length Side B: _____ m

Centre distance e: _____ m
(SS spacing)

Total assembly height from _____ to _____ mm
(Top edge of ground/finished floor/roof ↔ Top edge of board)

Nivello 2.0 required: Yes No
(to compensate a sloped subsurface)

Flooring dimensions*: _____ mm
(dimension A x dimension B x slab thickness)

* Refer to manufacturer's information on mounting stone slabs! Using our system does not exempt planners/installers from the need to inform themselves of the manufacturer's specifications for other products (installed in conjunction with our system).

Deck edging end profile: Yes No

Substructure with aluminium profile



System profile EVO
60 x 40 x 4000 mm
W x H x L

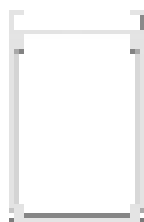

System profile EVO Slim
60 x 20 x 4000 mm
W x H x L

Support profile HKP
60 x 100 x 4000 mm
W x H x L

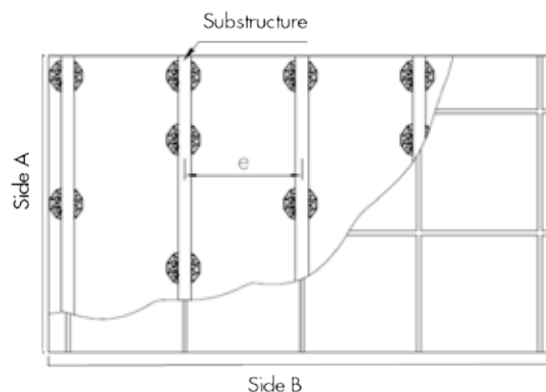

Cross bond

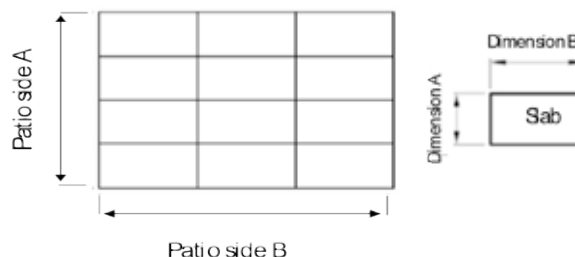

Stretcher bond

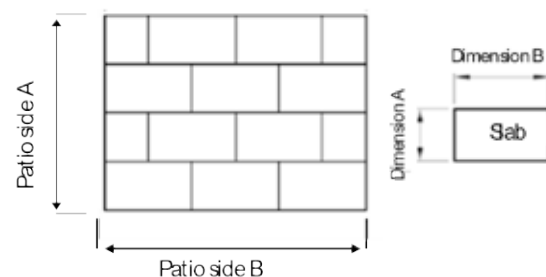

Free terrace software for material requirements planning

This innovative software was developed to make it easier to plan the materials you need for deck construction. Once a few key parameters are entered, the application offers you a choice of suitable products for the substructure, the substructure supports, and the materials for fastening the deck boards in place.



- **User-friendly**
- **Visualisation of substructure configuration**
- **Reliable planning**

Use the free software or download the inquiry form from our website:

www.eurotec.team

Deck substructure

Essential for a perfect deck

High-grade solutions for all types
of substructure

Without a perfect substructure, your deck will soon become defective. We offer a number of aids that let your deck remain attractive for a long time.

We will show you what's important!



Cork accessories for decking substructures

Cork, what is it?

Cork is a natural product obtained from the bark of the cork oak. The cork oak is a deciduous tree that is native primarily to the western Mediterranean, e.g. Spain and Portugal. To harvest the cork, the bark is peeled directly off the tree by hand.

As cork is a renewable natural product, a tree can be reharvested approx. every 10 years without causing damage to the tree. A cork oak has a life expectancy of up to 300 years and delivers approx. 100 to 200 kilograms of cork over its lifespan.

Free of PAHs
(hazardous plasticisers in rubber).

Properties and advantages

- Water-repellent (hydrophobic) and moisture-resistant
- Chemically neutral – free of PAHs (PAHs are toxic, carcinogenic plasticisers that are found primarily in rubber compounds)
- Does not decompose and is resistant to most acids and lye
- Dampens footfall sound, is non-slip and insulates against heat, noise and vibrations
- Resistant to rot, bacteria and germs
- Very pressure-stable and exhibits hardly any expansion
- Flame-resistant (fire class B2)

Cork is a sustainable, environmentally friendly natural product.



The cork pad spacers are laid between the deck substructure and the foundation/subsurface (self-adhesive on one side) and thus form a gap that aids constructive timber protection. The cork pad spacers are available in three sizes. These are 3 mm, 6 mm and 10 mm thickness/height (see Fig.). In addition to the advantages already mentioned, useful side effects of using the spacer include the option to adjust the height of the substructure and that the loads are distributed evenly.

Cork pad spacer

Self-adhesive



Art. no.	Dimensions [mm] ¹⁾	Material	PU
945397	3 x 70 x 70	Cork	25
945398	6 x 70 x 70	Cork	25
945399	10 x 70 x 70	Cork	25

¹⁾ Height x length x width

Roof-protection cork

The natural underlay for adjustable pedestals



Art. no.	Dimensions [mm] ¹⁾	Material	PU
945395	3 x 250 x 250	Cork	10

¹⁾ Height x length x width

Using adjustable deck pedestals on, for example, PVC sheet roofs can lead to problems because of the plasticisers contained in the roofing. The roof-protection cork provides natural protection against mechanical damage to the roof sheeting, at the same time as preventing contact between the two materials. Free of PAHs (hazardous plasticisers in rubber).

Accessories for decking substructures

Root control fleece underlay

Permeable polypropylene underlay.
Very limited permeability to water.
Inhibits plant growth under the fleece.



Art. no.	Dimensions [m]	Material	PU
944799	1,6 x 10,0	Polypropylene 50g/m ²	1

Rolfi, spacers

These spacers form a gap between the substructure and the foundation/support and thus help to protect the wood of the boarding beams.

Advantages

- Height adjustment of the substructure possible
- Even load distribution, minor irregularities are balanced out
- Dampens footfall noise



Art. no.	Dimensions [mm] ^{a)}	Material	PU
945966	3 x 60 x 60	EPDM, black	25
945967	6 x 60 x 60	EPDM, black	25
945379	10 x 60 x 60	EPDM, black	25

^{a)} Height x length x width

Protectus, timber-protection tape

The Protectus timber-protection tape provides lasting protection for your timber substructure from moisture, e.g. rain.

Advantages

- Constructive timber protection
- Easy fastening thanks to adhesive film
- Optimum fit thanks to very thin material
- Tear-proof and durable
- Screws can be screwed through easily
- Can be individually cut to length



Art. no.	Dimensions [mm] ^{a)}	PU
946157	0,5 x 20000 x 75	1

^{a)} Height x length x width

Rolfi roll

The Rolfi roll forms a gap between the deck substructure and foundation/subsurface.

Advantages

- Constructive timber protection
- Substructure height can be adjusted
- Uniform load distribution
- Small irregularities can be evened out
- Dampens footfall noise
- Can be individually cut to length



Art. no.	Dimensions [mm] ¹⁾	Material	PU
945561	8 x 2015 x 70	Granulated rubber	10

¹⁾ Height x length x width

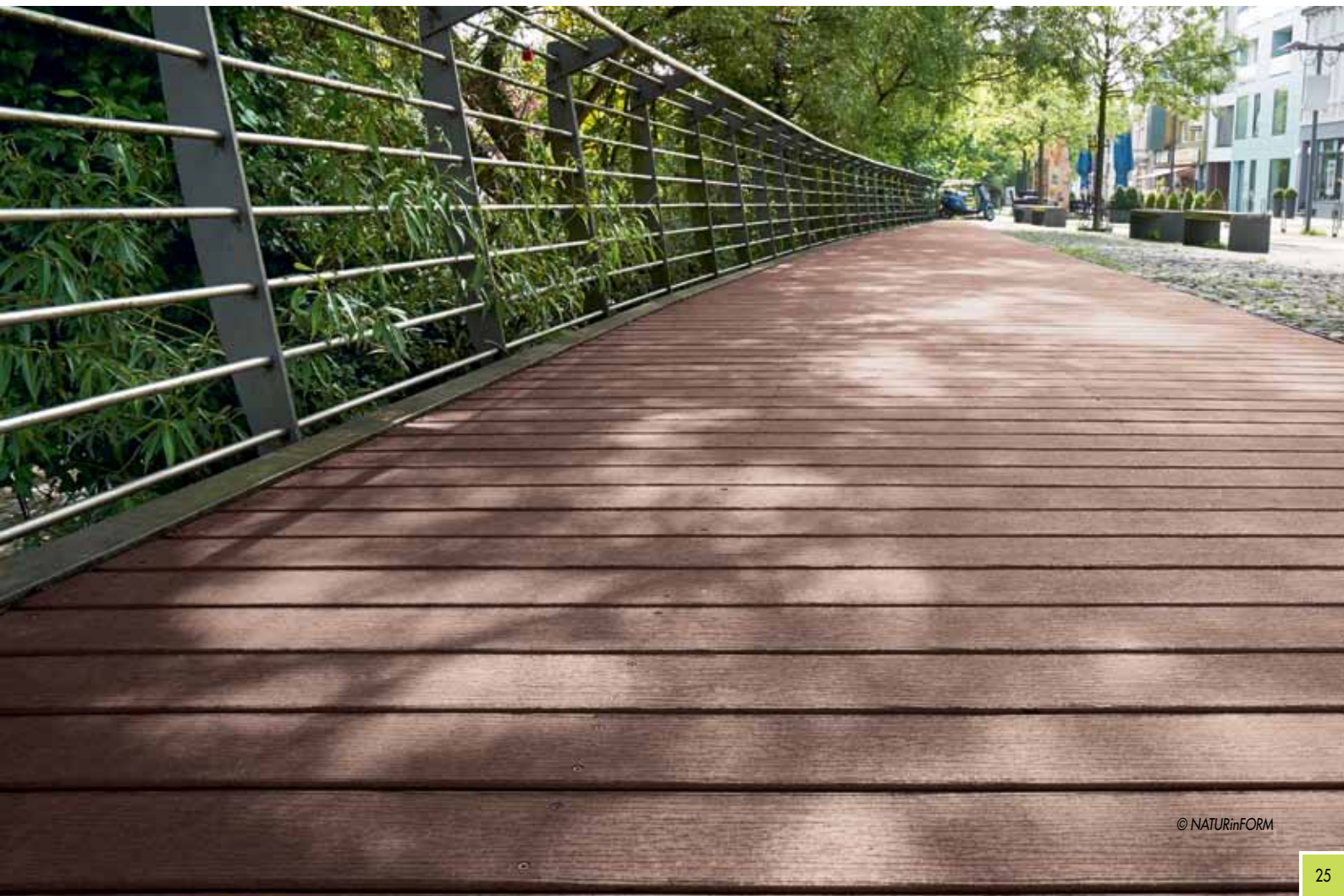

Eurotec Stone System

Building patios has never been so easy!

Multifunctional installation system

Numerous possibilities! Suitable for all common deck coverings.

The multifunctional installation system Stone System from Eurotec minimises the effort involved in constructing a patio. One unique practical feature of this system is that it can be combined with various deck coverings. You simply need a load-bearing foundation, the Stone System from Eurotec, and the desired deck covering.

Advantages

- Exceptionally economical
- Time-saving and straightforward installation
- Stone slabs can be combined with timber or WPC boards, for example
- Precise joint pattern
- Long-lasting
- Certified, high load-bearing capacity



For more information about the Stone system, please watch the application video on our YouTube channel

or download the Stone System brochure:
www.eurotec.team/en/catalogues





A perfectly constructed dream deck in just 8 steps

1 Selection of materials/quantity determination

2 Prepare foundation

3 Install PRO adjustable pedestals



4 Click EVO aluminium system profile onto adjustable pedestals and extend with EVO aluminium system profile connector so that the entire deck width is covered



5 Using EVO corner connectors, attach cross braces to provide transverse stiffening in substructure



6 Click the stone edge clips (at the edges) and the stone clips (within the paving) onto the EVO aluminium system profile



7 Insert first stone slab and check spacings

8 Align the substructure - uncomplicated and precise by means of variable adjustable pedestals - insert remaining stone slabs, done!

Overview of Eurotec adjustable pedestals

Properties/advantages

- High load-bearing capacity of up to 8 kN/pedestal
- Quick and easy assembly
- Stepless height adjustment
- Resistant to weather, UV exposure, insects and rot

BASE adjustable pedestals

- Suitable for substructures made of aluminium and timber
- Four different sizes available
- Can be combined with the BASE adapter L, 32, 40 and 60
- Assembly heights of 25 - 210 mm
- Load-bearing capacity of 2,2 kN/pedestal

Profi-Line adjustable pedestals

- Versatile applications thanks to a modular system comprising four base pedestals of different heights, two rings for increasing the height, and four adapters:
 - **L adapter** for substructures made of aluminium and timber
 - **Click adapter 40** for Evenco aluminium system profile
 - **Click adapter 60** for EVO/EVO Slim aluminium system profile and HKP deck-support profile
 - **Stone adapter** for laying floor slabs
- Basic assembly heights of 10 - 168 mm
- Additional heights possible with the extension rings and extension plate
- High load-bearing capacity of up to 8,0 kN/pedestal

SL PRO adjustable pedestals

- Self-levelling
- UV stability
- High fatigue strength
- Stepless height adjustment from 55 to 102 mm
- Can be combined with the L adapter
- Can be combined with the +4 and +10 extension rings
- Excellent chemical resistance
- Acoustic damping properties
- High load-bearing capacity of up to 8,0 kN/pedestal

NEW
to our product range



NEW
to our product range

BASE-Line adjustable pedestals

BASE 1



Art. no.	Name	Assembly height [mm]	Load-bearing capacity [kN]*	PU **
100000	BASE 1	25 - 40	2,2	50

BASE 2



Art. no.	Name	Assembly height [mm]	Load-bearing capacity [kN]*	PU **
100001	BASE 2	35 - 60	2,2	50

BASE 3



Art. no.	Name	Assembly height [mm]	Load-bearing capacity [kN]*	PU **
100002	BASE 3	60 - 110	2,2	30

BASE 4



Art. no.	Name	Assembly height [mm]	Load-bearing capacity [kN]*	PU **
100003	BASE 4	110 - 210	2,2	20

Note: The BASE-Line is not compatible with the Nivello 2.0

* The quoted load-bearing capacities represent recommended values. With these loads, the adjustable pedestals only deform by approx. 2 mm. The load-bearing capacity before actual fracture is multiple times higher.

** The BASE adjustable pedestal is supplied with the BASE L adapter and one screw each per adjustable pedestal as standard. If the BASE adjustable pedestals are used for aluminium, suitable adapters must be purchased too.

The adjustable pedestals series is completed by four different types of adapter:

BASE L adapter - for classic timber substructures or modern aluminium substructures

BASE adapter 32/40/60 - for clicking Eurotec aluminium profiles into place in a time-saving manner

NEW
to our product range

BASE L adapter

For aluminium or timber profiles

Suitable for the
BASE 1,2,3 and 4



Art. no.	Name	PU*
	BASE L adapter	

* The BASE L adapter is included in the scope of delivery as standard.

BASE adapter 32

For aluminium profiles with Click system

Suitable for EVO Light
aluminium system profile



Art. no.	Name	PU
100004	BASE adapter 32	10

BASE adapter 40

For aluminium profiles with Click system

Suitable for Eveco aluminium
system profile



Art. no.	Name	PU
100005	BASE adapter 40	10

BASE adapter 60

For aluminium profiles with Click system

Suitable for EVO/EVO Slim
aluminium system profile and
HKP deck-support profile



Art. no.	Name	PU
100006	BASE adapter 60	10



Eurotec

Eurotec

Profi-Line adjustable pedestals with modular system

Innovative, universal, versatile and user-friendly!

The Profi-Line adjustable pedestal series comprises four adjustable pedestals of different heights whose assembly heights can be altered using extension rings.

PRO XXS



Art. no.	Name	Assembly height [mm]	Load-bearing capacity [kN]*	PU
954020	PRO XXS	10 - 15	4,0	50

The PRO XXS comes with both an L-adapter and stone adapter.

The adjustable foot XXS can be combined with up to two extension plates XXS for height expansion.

Note: The adapters for the XXS adjustable pedestal are only suitable for the XXS and cannot be combined with the rest of the PRO family. Not compatible with the Nivello 2.0.

XXS extension plate

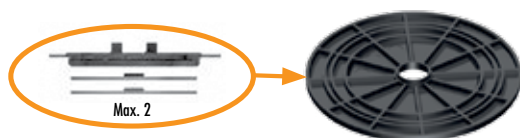

Art. no.	Name	Assembly height [mm]	Load-bearing capacity [kN]*	PU
954021	XXS extension plate	5	4,0	50

PRO XS / PRO S



Art. no.	Name	Assembly height [mm]	Load-bearing capacity [kN]*	PU
954061	PRO XS	22 - 30	8,0	20
946070	PRO S	30 - 53	8,0	10

The PRO XS comes with both an L-adapter and stone adapter.

PRO S: Height adjustable in 3 stages of 5 mm each and an additional 8 mm can be combined with the thread.

Note: The adapters for the XS adjustable pedestal are only suitable for the XS and cannot be combined with the rest of the PRO family. The adjustable pedestal XS is not compatible with the Nivello 2.0.

PRO M



Art. no.	Name	Assembly height [mm]	Load-bearing capacity [kN]*	PU
946071	PRO M	53 - 82	8,0	10

PRO L

Fixing by means of Thermofix screw 4.2 x 22 mm (item no. 945969, see page 77) is possible on all PRO pedestals.



Art. no.	Name	Assembly height [mm]	Load-bearing capacity [kN]*	PU
946072	PRO L	70 - 117	8,0	10

* The quoted load-bearing capacities represent recommended values. With these loads, the adjustable pedestals only deform by approx. 2 mm. The load-bearing capacity before actual fracture is multiple times higher.

PRO XL



Art. no.	Name	Assembly height [mm]	Load-bearing capacity [kN]*	PU
946079	PRO XL	74 - 168	8,0	10

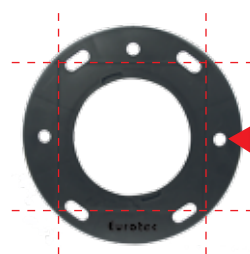

If necessary, the base plate of the adjustable feet PRO and SL PRO can be easily cut with a cutting knife along the cutting marks.

The adjustable pedestals series is completed by three different types of adapter:

L adapters - for classic timber substructures or modern aluminium substructures

Click adapters - for clicking Eurotec aluminium profiles into place in a time-saving manner

Stone adapters - for laying stone slabs

Extension rings

For increasing the height of the PRO adjustable pedestals



Suitable for the PRO S, M, L and XL as well as SL PRO M and L adjustable pedestals

Art. no.	Name	Assembly height [mm]	Load-bearing capacity [kN]*	PU
946074	Extension ring + 4	40	8,0	10
946073	Extension ring +10	100	8,0	10

L adapter

For aluminium or timber profiles

Suitable for the PRO S, M, L and XL as well as SL PRO M and L adjustable pedestals

incl.
one screw
per adapter!



Art. no.	Name	Art. no.	PU
946075	L adapter		10

Click adapter

For aluminium profiles with Click system



Click adapter 40

for Evcco aluminium system profile.

Suitable for PRO S - PRO XL

Click adapter 60

for EVO/EVO Slim aluminium system profile and HKP deck-support profile.

Suitable for PRO S - PRO XL

Art. no.	Name	Art. no.	PU
946076	Click adapter 40		10
946077	Click adapter 60		10

Stone adapter

For stone slabs

Suitable for the PRO S, M, L and XL adjustable pedestals



Art. no.	Name	Dimension joint spacer [mm] ¹⁾	PU
946078	Stone adapter	8 x 14 x 4	10

¹⁾ Height x length x width

Possible combinations

Adjustable pedestals	L adapter	Click adapter 40	Click adapter 60	Stone adapter	L/stone adapter XXS	L/stone adapter XS
PRO XXS					X	
PRO XS						X
PRO S	X	X	X	X		
PRO M	X	X	X	X		
PRO L	X	X	X	X		
PRO XL	X	X	X	X		
SL PRO M	X					
SL PRO L	X					

* The quoted load-bearing capacities represent recommended values. With these loads, the adjustable pedestals only deform by approx. 2 mm. The load-bearing capacity before actual fracture is multiple times higher.

SL PRO adjustable pedestals

The Eurotec SL PRO adjustable pedestal is suitable for installing deck substructures in outdoor applications. The head of the SL PRO adjustable pedestal features stepless self-levelling and ensures that slopes of up to 8% on surfaces and uneven ground can be evened out.

The most important advantage is, that no additional slope compensation is required to establish the correct alignment of the covering surface. The SL PRO adjustable pedestal therefore allows the easy creation of an inclination of 1-2% on deck surfaces for drainage purposes.

Advantages

- Self-levelling for slopes of up to 8%
- UV stability
- High fatigue strength
- Stepless height adjustment from 55 to 102 mm
- Excellent chemical resistance
- Acoustic damping properties



SL PRO M



Art. no.	Name	Assembly height [mm]*	Load-bearing capacity [kN]	PU
946071-SL	SL PRO M	55 - 84	8,0	10

* The adapter must be attached to produce an assembly height in the adjustment range!

SL PRO L



Art. no.	Name	Assembly height [mm]*	Load-bearing capacity [kN]	PU
946072-SL	SL PRO L	73 - 102	8,0	10

* The adapter must be attached to produce an assembly height in the adjustment range!

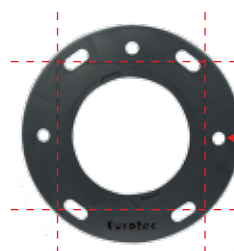

If necessary, the base plate of the adjustable feet PRO and SL PRO can be easily cut with a cutting knife along the cutting marks.

Nivello 2.0

For PRO-Line adjustable pedestals

Nivello 2.0



Art. no.	Slope (%)	PU
946035	0,5 - 10	10

- User-friendly operation
- Versatile slope adjustment
 - Minimum slope: 0,5 %
 - Maximum slope: 10 %
 - Slope can be adjusted in steps of 0,5%
- Click-locking of adjustable pedestals
- Bearing surface composition protects subsurface (e.g. roofing)
- Large bearing surface

Note Not compatible with adjustable pedestals PRO XS, PRO XXS and BASE-Line.

Aids for installing stone slabs

Slab supports

- Support height: 10 mm
- Joint spacer: 4 mm
- Up to three units can be stacked on top of one another
- Dampens footfall noise



Art. no.	Dimensions [mm] ^{a)}	Material	PU
945432	Ø 120 x 18/10	EPDM, black	45

a) Outside diameter x total height/Support height of a plate bearing



Also ideal for your roof terrace

Thanks to modern slab support and special adjustable pedestals for slabs, it is now possible to lay floor slabs easily and without mortar. The different support heights of the slab supports and adjustable pedestals allow you to easily correct height differences in the subfloor and to cover up unsightly outflows and drains. You can therefore achieve an even surface with little effort. Any surface water that arises can run off quickly and easily through the seams.

In order to achieve an even surface with the stone slabs, the height can be adjusted down to the last millimetre using gearwheels in the Quattro-Lager.

Quattro Lager

With slab spacer

- Four different support heights are possible thanks to individually adjustable gearwheels
- Support height: 35 - 55 mm
- Joint spacer: 6 mm
- The height can be extended by placing the Quattro-Lager adapter underneath
- Can be split



Art. no.	Dimensions [mm]	Load capacity per corner [kN]*	Total load capacity [kN]*	PU
945340	35 - 55	2,0	8,0	15

Adapter

For Quattro Lager

- Support height: 20 mm
- Can be split
- Stackable



Art. no.	Dimensions [mm]	Total load capacity [kN]*	PU
945342	Ø 150 x 20	8,0	20

* The quoted load-bearing capacities represent recommended values. With these loads, the adjustable pedestals only deform by approx. 2 mm. The load-bearing capacity before actual fracture is multiple times higher.

Stone slab spacers

The simple aids for installing stone slabs

Stone slab spacer



15 x 53 x 3 mm 30 x 53 x 3 mm 15 x 53 x 5 mm 30 x 53 x 5 mm

Stone slab spacer

With baseplate

Large baseplate prevents slab spacers from being pressed into gravel bed



Art. no.	Dimensions [mm] ^{a)}	Material	PU
945336	15 x 53 x 3	PP	100
945338	30 x 53 x 3	PP	100
945335	15 x 53 x 5	PP	100
945337	30 x 53 x 5	PP	100

^{a)} Bridge height x length x joint dimension

Art. no.	Dimensions [mm] ^{a)}	Material	PU
945339	15 x 53 x 3	PP	100

^{a)} Bridge height x length x joint dimension

Advantages of stone slab spacers

- Uniform joint pattern
- Optimum drainage
- They prevent the floor slabs from rubbing against one another and therefore prevent damage to the slab edges.
- They have predetermined breaking points and are therefore suitable for T-joints and cross joints.
- Durable
- Resistant to temperature and weathering
- Resistant to acids, alkalis and other chemicals

Quantity calculation for laying floor slabs

Floor slab	Pieces/m ²
40 x 40 cm	ca. 7,8
50 x 50 cm	ca. 4,8
40 x 60 cm	ca. 5,6
60 x 60 cm	ca. 4,0

There are approximate figures based on an area of 25 m² (5 x 5 m).

Compensation disk Ø90



NEW
to our product range

Art. no.	Dimensions [mm]	PU
954089	Ø 90; height 2,5	50

- For balancing out unevenness in the slabs
- Can be mounted on the adjustable pedestals from the Profi-Line series, SL PRO series and BASE-Line series with stone adapter, as well as on the Stone-Edge-Clip, Flex-Stone-Clip and the plate bearing
- Can be split into up to four parts

Compensation disk Ø150



Art. no.	Dimensions [mm]	PU
954064*	Ø 150; height 2,5	10

* Discontinued item

- For balancing out unevenness in the slabs
- Can simply be laid onto PRO adjustable pedestals with stone adapter
- Can be split into up to four parts

Stone slab lifter



Art. no.	Span [cm]	Nominal Load [kg]	PU
954045	30,0 - 50,0	25	1

- Simplifies and speeds up the lifting and laying of floor slabs
- Also suitable for subsequent lifting of already laid slabs

Accessories



Aids for laying slabs and tiles

The Eurotec Level Mate is a reusable levelling system for tiles. The system is also suitable for use by both experienced tradespeople and DIY enthusiasts. The Level Mate is particularly suitable when using slabs and tiles.

Level Mate Spin

After inserting the Level Mate Spin into the joint, turn it by 90° and thus hook it on the underside of the tile.

Hold the red handle first of all and turn the black nut tightly around the slabs to level them.

To remove the Level Mate, loosen the black nut and turn the red handle by 90° again.



Advantages

- Easy to assemble
- No embedded base
- No consumables
- Reusable
- No additional components needed

Art. no.	Name	PU
945346	Level Mate Spin	20

For joint widths of 1,5 mm to 5 mm.
Slab thicknesses of 3 mm to 15 mm.

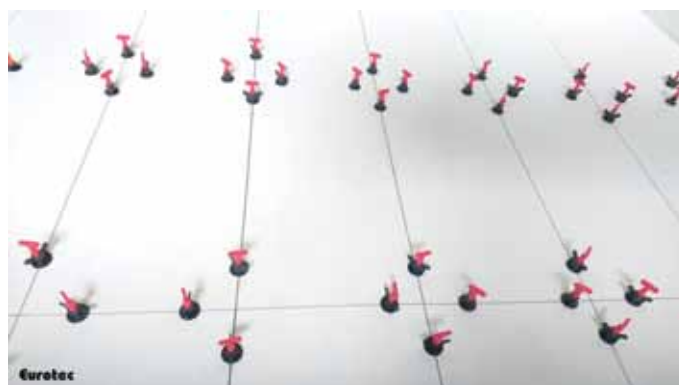

Level Mate Flip

After inserting the Level Mate Flip, turn it by 90° and thus hook it on the underside of the tile. You can level your slabs by folding down the red lever. Thanks to the snap-in function, it can be used for all standard slab thicknesses. To remove the Level Mate Flip, loosen the lever and turn it by 90° again.



Art. no.	Name	PU
945347	Level Mate Flip	20

For joint widths of 2 mm to 5 mm.
Slab thicknesses of 8 mm to 11 mm.

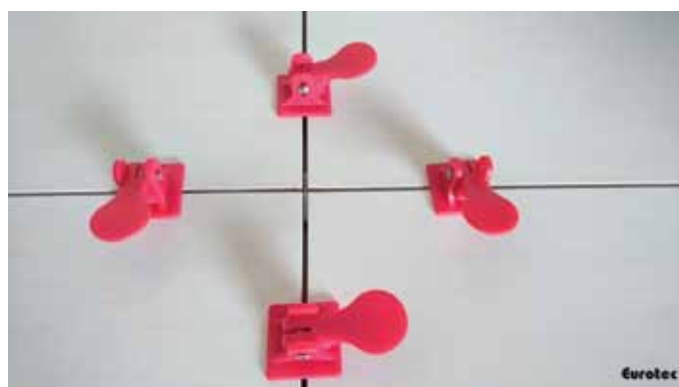

3 mm spacer



Art. no.	Name	PU
945348	3 mm spacer	200

Robusto deck pedestal

Robusto deck pedestal HV 500+350



What can it be used for?

- Deck construction
- For example, for the construction of barrier-free ramps and transitions
- Thanks to its U-shaped head plate, the Robusto HV 500+350 can support not only the Eurotec HKP deck-support profile but also the EVO aluminium system profile and timber substructure profiles.

Properties

- Meets the requirements for structural wood protection

Advantages

- An EPDM gasket between the head plate and substructure provides additional protection against footfall sound and penetrating moisture
- The height of the post foot can be adjusted to up to 850 mm after assembly
- Thanks to the height adjustment, manufacturing tolerances relating to the structure and subsequent settlement in the individual foundations can be balanced out
- High tensile and compressive load capacities

Notes

- The durability of the pedestals is ensured thanks to hot-dip galvanisation in accordance with DIN EN ISO 12944-2 (C3).

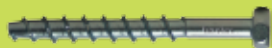

Suitable for this:
Rock concrete screw hexagonal
BIM A2 10,5 x 95 mm
Art. no.: 110355

The deck pedestal in combination with the HKP deck-support profile



With the deck pedestal, it is possible to build accessible ramps and transitions



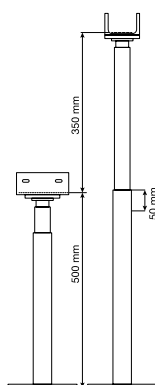
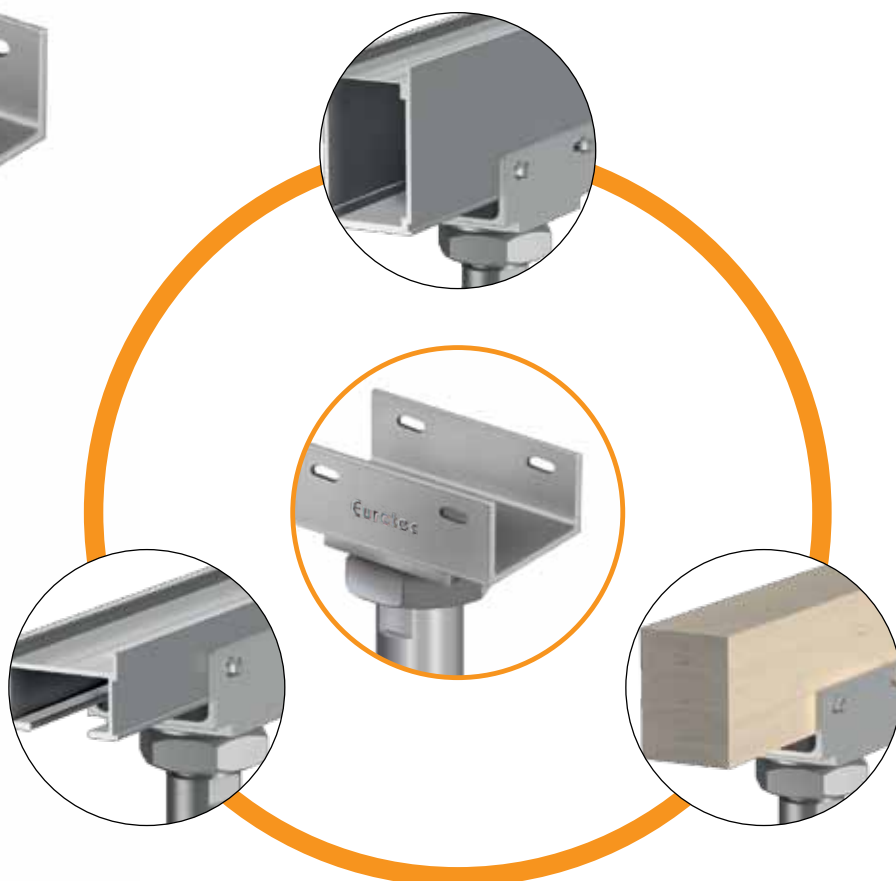
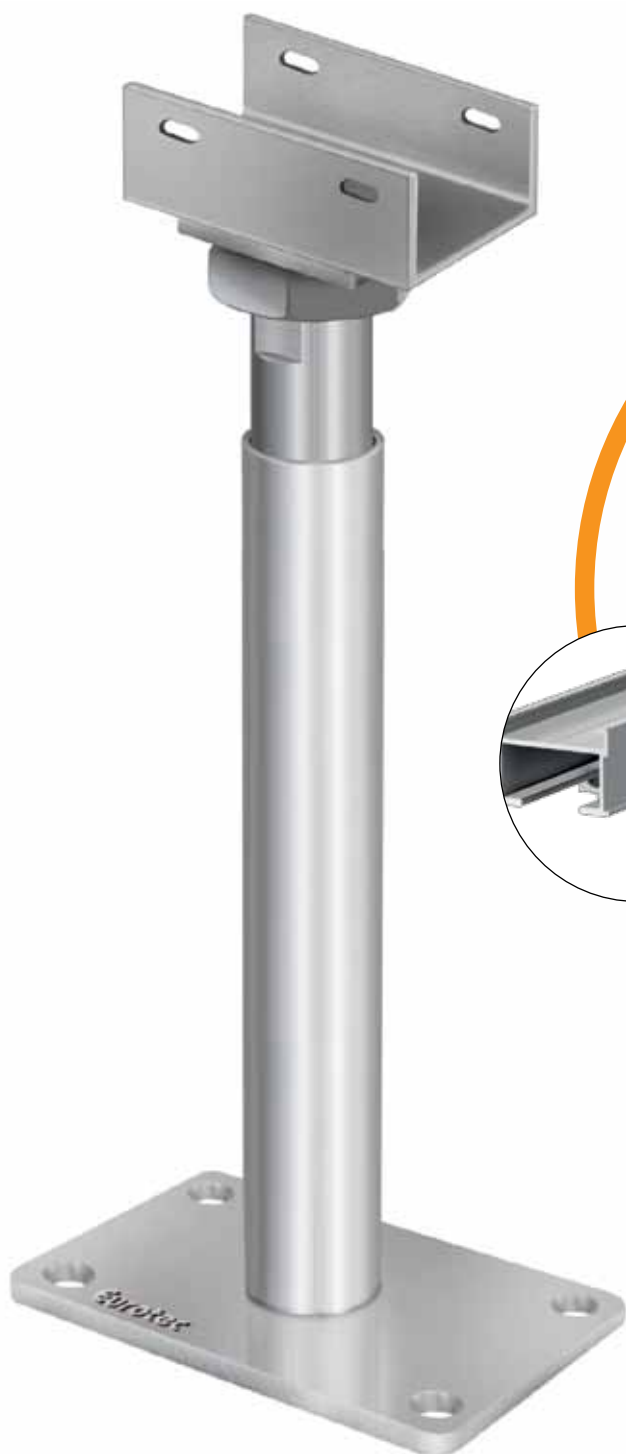

Brief technical description

- Simple assembly with U-shaped head plate
- Can be combined with the HKP deck-support profile and the EVO aluminium system profile
- Min. timber cross section of 60 x 100 mm
- Additional timber protection thanks to EPDM for timber
- Hot-dip galvanised structural steel S235JR (ST37-2)
- Can be used in the usage classes 1, 2 and 3 in accordance with DIN EN 1995-1 -1
- The Robusto HV 500+350 allows constructive timber protection in accordance with the new DIN 68800-2
- In addition to the vertical loads, the Robusto HV 500+350 can also transfer horizontal forces into the subsurface

Name	Art. no.	Height adjustment in assembled state	Min. post cross section	Dimensions of baseplate	Compressive load-bearing capacity	Tensile load-bearing capacity	Lateral force resistance ¹⁾	PU
Post feet on concrete		[mm]	[mm]	L x W x H [mm]	N _{c,d} [kN]	N _{t,d} [kN]	VR _d [kN]	pcs.
Robusto HV 500+350	904661	500 - 850	60 x 100	160 x 100 x 8	21,2	9,2	-	1

Please note

The stated values are intended as planning aids. They are subject to typographical and printing errors. Projects must only be calculated by authorised persons.

1) The lateral force resistance must be overlaid with the compressive and tensile load in accordance with ETA 13-/0550 and can therefore lead to lower load-bearing capacities.

Overview of Eurotec aluminium profiles

Properties/advantages

- Form-stable, always straight, load-bearing, torsion-free
- Resistant to weather, UV exposure, insects and rot
- The special shape of the profiles reduces the risk of fastening screws shearing off as a result of swelling and shrinking movements of the deck boards
- Supporting constructive timber protection

EVO aluminium system profile

- Suitable for Profi-Line and BASE-Line adjustable pedestals
- For visible and hidden fastening of deck boards, e.g. Twin System Clip
- Can be extended using EVO/EVO Slim aluminium system-profile connectors

EVO Slim aluminium system profile

- Suitable for Profi-Line and BASE-Line adjustable pedestals
- For visible and hidden fastening of deck boards, e.g. Twin System Clip
- Can be extended using EVO Slim aluminium system-profile connectors
- Especially designed to suit low assembly heights

EVO Light aluminium system profile

- Developed specially for BASE adjustable pedestals
- For visible and hidden fastening of deck boards, for example with the EVO Light system clip
- Can be extended using EVO Light system connector





Eveco aluminium system profile

- Developed specially for PRO adjustable pedestals with Click adapter
- In case of low structure height, the profile can be used without pedestals
- The aluminium profiles are simply clicked into place – with no need for screwing
- Hidden fastening of deck boards with ECO system clip
- Can be extended using ECO system connector

HKP deck support system

- Suitable for Profi-Line and BASE-Line adjustable pedestals
- For bridging large spans
- Consists of two system parts
- For visible and hidden fastening of deck boards

Aluminium function strips

- Used without adjustable pedestals
- For low assembly heights
- With footfall sound insulation thanks to glued-in cork insert
- For visible fastening of deck boards

DiLo aluminium function strip

- Used without adjustable pedestals
- For low assembly heights
- For hidden fastening of deck boards

EVO aluminium system profile

The EVO aluminium system profile is one of the alternatives to a deck substructure made of timber.

- In contrast to timber substructures, the profile is dimensionally stable and straight
- It doesn't suffer from climate-related effects such as warping, cracks, etc. that naturally occur with timber.
- The special shape prevents the screws from shearing off
- Allows both hidden and visible fastening

Suitable for Profi-Line and BASE-Line adjustable pedestals!

Example:
Adjustable pedestal PRO with L adapter



using a deck glider on a Black Edition EVO aluminium system profile



using a profile drilling screw on an EVO aluminium system profile

EVO/EVO Black Edition aluminium system profile



Art. no.	Dimensions [mm] ^{a)}	Material	PU
975621	40 x 60 x 2400	Aluminium	1
975610	40 x 60 x 4000	Aluminium	1
S975621	40 x 60 x 2400	Aluminium, black	1
S975610	40 x 60 x 4000	Aluminium, black	1

^{a)} Height x Width x Profile length



Use the aluminium concrete bracket (Art.-no.: 975661) for fixing to concrete. Find more information on page 52

Cross-section values ^{b)}		
E-Modul [N/mm ²]	Wy [mm ³]	Iy [mm ⁴]
70000	3438	70480

Wy = section modulus; Iy = geometrical moment of inertia

Max. support spacing L [mm] for EVO aluminium system profile with adjustable pedestals^{a)}

Payload [kN/m ²]	BASE-Line adjustable pedestals, perm. F = 2,2 kN							
	Centre distance e [mm] between the profiles ^{b)}							
	300	350	400	450	500	550	600	800
2,0	1000	1000	900	800	750	600	600	450
4,0 ^{c)}	750	650	550	500	450	400	350	250
5,0 ^{d)}	650	550	450	400	350	350	300	-

Payload [kN/m ²]	Profi-Line adjustable pedestals, perm. F = 8,0 kN							
	Centre distance e [mm] between the profiles							
	300	350	400	450	500	550	600	800
2,0	1000	1000	1000	950	900	850	850	750
3,0 ^{c)}	1000	950	900	850	850	800	800	700
4,0 ^{c)}	900	850	850	800	750	750	700	650
5,0 ^{d)}	850	800	800	750	700	700	650	600

^{a)} Indication of max. span at which the profile's deflection does not exceed L/300. Average board thickness of 25 mm with a specific weight of 7 kN/m² (larch, pine, Douglas fir).

^{b)} e.g.: spacing between profiles = 550 mm; payload = 2,0 kN/m² → max. span of the profile = 600 mm.

^{c)} Payloads according to DIN EN 1991-1; roof terraces = 4 kN/m², patios for public use = 5 kN/m².

^{d)} Load capacity according to SIA 261 for balconies and roof terraces private use = 3 kN/m²

EVO aluminium system profile connector



Note

The profile butt joint is only to be positioned directly above a post or support.

Art. no.	Dimensions [mm] ^{a)}	Material	PU*
975611	24 x 200 x 50	Aluminium	10

^{a)} Height x length x width
*Incl. 4 drilling screws per connector

Example of fixing an EVO aluminium profile connector

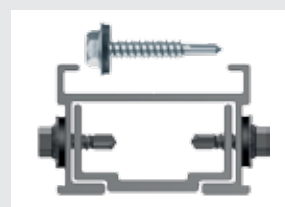

EVO corner connector



Art. no.	Dimensions [mm] ^{a)}	Material	PU
975612-10	40 x 40 x 25	Aluminium	10*
975612-200	40 x 40 x 25	Aluminium	200**

^{a)} Height x length x width
* incl. 40 screws
** incl. 800 screws



EVO wall-connection bracket / EVO position anchor

Suitable for the
**EVO aluminium
system profile**

EVO wall-connection bracket

Properties

- Slot diameter: 6 mm or 7 mm
- Slot length: 15 mm
- Material thickness: 3 mm



Art. no.	Dimensions [mm]	Material	PU*
975627	100 x 30	Aluminium	10

* Supplied with 1 drilling screw per wall-connection bracket for attachment to the EVO aluminium system profile.

The **EVO wall-connection bracket** is ideal for use as a position anchor for deck substructures made of aluminium. The bracket is used to fasten the EVO aluminium system profile directly to the wall. Two EVO wall-connection brackets are needed per aluminium profile. The slots in the wall-connection bracket allow the substructure to expand without problems and therefore prevent it from shifting out of position.



EVO position anchor

Advantages

- Versatile applications
- Corrosion-resistant
- Easy to use



The EVO position anchor provides a simple and straightforward solution for joining Eurotec EVO aluminium system profiles. Thanks to the EVO position anchor, the aluminium profiles can be joined at an angle of between 30° and 90°.

Art. no.	Dimensions [mm] ⁰⁾	Thickness [mm]	Material	PU*
975622	27,5 x 49 x 23,5	2,5	Zinc die-cast	10

⁰⁾ Height x length x width

* Comes supplied with screws



View of substructure from below

90° / 180° EVO joint

EVO pivots are used to join the EVO aluminium system profiles. The pivots can rotate freely on both sides and can be used for angles of up to 90° or 180° in deck substructures.

90° EVO joint

Advantages

- Freely rotating joint
- For angles of up to 90°
- Individual positioning in the EVO system profile

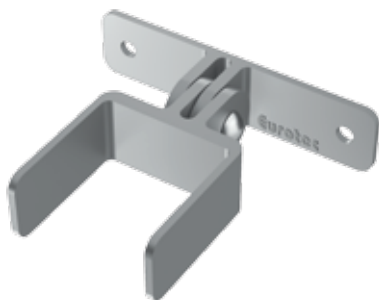

Art. no.	Dimensions [mm] ⁰⁾	Material	PU*
975623	23,5 x 84,0 x 100	Zinc die-cast	4

⁰⁾ Height x length x width

* For fastening, we recommend using Eurotec Bighty PH drilling screws. These are not included in the product.



180° EVO joint

Advantages

- Freely rotating joint
- For angles of up to 180°
- Individual positioning in the EVO system profile

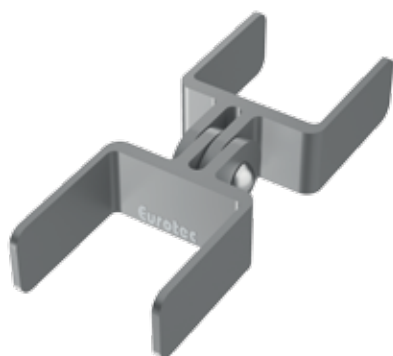

Art. no.	Dimensions [mm] ⁰⁾	Material	PU*
975624	23,5 x 131,5 x 49,25	Zinc die-cast	4

⁰⁾ Height x length x width

* For fastening, we recommend using Eurotec Bighty PH drilling screws. These are not included in the product.



EVO Slim aluminium system profile

The EVO Slim aluminium system profile is especially developed to suit low assembly heights. It can be combined with our BASE-Line and Profi-Line adjustable pedestals and is therefore also ideal for the multifunctional Stone System.

EVO Slim aluminium system profile



Art. no.	Dimensions [mm] ^{a)}	Material	PU
975633	20 x 2400 x 60	Aluminium	1
975628	20 x 4000 x 60	Aluminium	1

^{a)} Height x profile length x width

Important! If the Aluminium-System Profile EVO-Slim is installed in combination with the Twin system clip, the note on page 73 needs to be considered.

EVO Slim aluminium system profile connector



Art. no.	Dimensions [mm] ^{a)}	Material	PU*
975629	4 x 200 x 48	Aluminium	10

^{a)} Height x length x width

*Incl. 4 drilling screws per connector

Note

The profile butt joint is only to be positioned directly above a post or support.

Max. support spacing L [mm] for EVO Slim aluminium system profile with adjustable pedestals^{a)}

Payload [kN/m ²]	BASE-Line adjustable pedestals, perm. F = 2,2 kN							
	Centre distance e [mm] between the profiles ^{b)}							
	250	300	350	400	450	500	550	600
2,0	650	600	600	550	550	500	500	500
3,0 ^{b)}	550	550	500	500	500	450	450	400
4,0 ^{c)}	500	500	450	450	400	400	400	400
5,0 ^{d)}	500	450	450	400	400	400	350	350

Payload [kN/m ²]	Profi-Line adjustable pedestals, perm. F = 8,0 kN							
	Centre distance e [mm] between the profiles ^{b)}							
	250	300	350	400	450	500	550	600
2,0	650	600	600	550	550	500	500	500
3,0 ^{b)}	550	550	500	500	500	450	450	400
4,0 ^{c)}	500	500	450	450	400	400	400	400
5,0 ^{d)}	500	450	450	400	400	400	350	350

^{a)} Indication of max. span at which the profile's deflection does not exceed L/300. Average board thickness of 25 mm with a specific weight of 7 kN/m³ (larch, pine, Douglas fir).

^{b)} e.g.: spacing between profiles = 550 mm; payload = 2,0 kN/m² → max. span of the profile = 500 mm.

^{c)} Payloads according to DIN EN 1991-1-1; roof terraces = 4 kN/m², patios for public use = 5 kN/m².

^{d)} Load capacity according to SIA 261 for balconies and roof terraces private use = 3 kN/m².

Note

Please refer to the assembly instructions in our product data sheet.



Accessories for the multifunctional Stone System

Flex-Stone-Clip

For clicking onto the EVO aluminium system profile within the paving



Art. no.	Joint spacer dimensions [mm] ¹⁾	PU*
975602	8 x 14 x 4	200

¹⁾ Height x length x width

* For fastening, we recommend using Aluminium profile drilling screw (645026).
These are not included.

Note

The flexibility of the Flex-Stone-Clip allows it to compensate for manufacturing tolerances of up to 2 mm in stone slabs.

Stone-Edge-Clip

For clicking onto the EVO aluminium system profile at the edges



Art. no.	Joint spacer dimensions [mm] ¹⁾	PU*
975603	8 x 14 x 4	50

¹⁾ Height x length x width

* Comes supplied with one screw per clip.

To prevent individual stone slabs from slipping, the stone edge clips are to be screwed to the aluminium substructure in the edge area. The clips have a screw channel in the middle for this purpose.

Aluminium profile drilling screw



Art. no.	Dimensions [mm]	Drive	PU
645026	4,2 x 35	TX15 •	100

EVO Light aluminium system profiles + accessories

EVO Light aluminium system profile



Art. no.	Dimensions [mm] ¹⁾	Material	PU
975643	32 x 4000 x 34	Aluminium	1

¹⁾ Height x profile length x width



Use the aluminium concrete bracket (Art.-no.: 975661) for fixing to concrete. Find more information on page 52

Properties

- Hidden fastening with the EVO Light system clip
- Visible fastening with Eurotec profile drilling screws and wing-tipped profile drilling screws
- Developed specially for BASE adjustable pedestals
- Can also be used with PRO adjustable pedestals and L adapter
- Can be extended using ECO Light system connector
- Position retention due to screw of L adapter
- Load-bearing, torsion-free, form-stable and straight
- Special shape prevents screws from shearing off

EVO Light system connector



Art. no.	Dimensions [mm] ¹⁾	Material	PU
975618	27,7 x 62,5 x 27,4	Plastic	10

¹⁾ Height x length x width



For connecting the aluminium EVO Light system profiles together. The EVO Light system connector has the advantage that it connects the profiles without screws, simply by plugging them together.

Corner connectors

Suitable for EVO Light aluminium system profiles

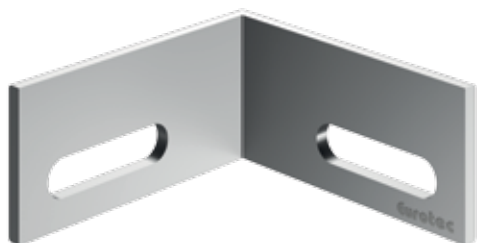

Art. no.	Dimensions [mm] ¹⁾	Material	PU*
975631	40 x 40 x 19	Aluminium	10

¹⁾ Height x length x width

* incl. 20 screws

Max. support spacing (L) for EVO Light aluminium system profile without adjustable pedestals, e.g. on concrete foundations^{a)}

Payload [kN/m ²]	Centre distance e [mm] between profiles ^{b)}							
	250	300	350	400	450	500	550	600
2,0	950	900	850	850	800	750	750	700
4,0 ^{c)}	800	750	700	650	600	600	600	550
5,0 ^{d)}	700	700	650	600	550	550	550	500

^{a)} Max. support spacing (L) for load capacities of 2, 4 and 5 kN/m², with an average board thickness of 25 mm and a specific board weight of 7 kN/m³ (larch, pine, Douglas fir).

^{b)} If WPC boards are used, the centre distance e between the profiles must not exceed 400 mm!

^{c)} Load capacities according to DIN EN 1991-1; roof terraces = 4 kN/m², decks for public use = 5 kN/m².

Max. support spacing (L) for EVO Light aluminium system profile with adjustable pedestals^{a)}

Payload [kN/m ²]	BASE adjustable pedestals, perm. F = 2,2 kN							
	Centre distance e [mm] between profiles ^{b)}							
	250	300	350	400	450	500	550	600
2,0	950	900	850	850	800	750	750	700
3,0 ^{d)}	850	800	750	750	700	650	650	600
4,0 ^{c)}	800	750	700	650	600	550	500	450
5,0 ^{d)}	700	700	650	550	500	450	400	350

Payload [kN/m ²]	PRO adjustable pedestals, perm. F = 8,0 kN							
	Centre distance e [mm] between profiles ^{b)}							
	250	300	350	400	450	500	550	600
2,0	950	900	850	850	800	750	750	700
3,0 ^{d)}	850	800	750	750	700	650	650	600
4,0 ^{c)}	800	750	700	650	600	600	600	550
5,0 ^{d)}	700	700	650	600	550	550	550	500

^{a)} Max. support spacing (L) for load capacities of 2, 3, 4 and 5 kN/m², with an average board thickness of 25 mm and a specific board weight of 7 kN/m³ (larch, pine, Douglas fir).

^{b)} If WPC boards are used, the centre distance e between the profiles must not exceed 400 mm!

^{c)} Load capacities according to DIN EN 1991-1; roof terraces = 4 kN/m², decks for public use = 5 kN/m².

^{d)} Load capacity according to SIA 261 for balconies and roof terraces private use = 3 kN/m².

MaTre band

For material separation

Suitable for
EVO, EVO
Light and
HKP



The MaTre band is used for material separation and thus prevents creaking noises between the aluminium profiles and planks.

Advantages

- Easy attachment thanks to an adhesive film
- Optimal fit through a very thin material
- Tear resistant and durable
- Screws can be easily screwed
- Can be cut to length individually

Art. no.	Dimensions [mm] ^{a)}	PU
945319	0,5 x 20000 x 10	5

^{a)} Height x length x width



Eveco aluminium system profiles + accessories

Eveco aluminium system profile



Art. no.	Dimensions [mm] ^{a)}	Material	PU
975632	24 x 2400 x 39	Aluminium	1
975630	24 x 4000 x 39	Aluminium	1

^{a)} Height x length x width



Use the aluminium concrete bracket (Art.-no.: 975661) for fixing to concrete. Find more information on page 52

Properties

- Can be combined with ECO system clip for hidden fastening
- Universal: can also be used with many other fastening clips (screw diameter: 4,2 mm)
- Developed specially for PRO adjustable pedestals with Click adapter 40
- In case of low structure height, the profile can be used without pedestals
- Position retention thanks to Click system without screws
- Load-bearing, torsion-free, form-stable and straight
- Screw channel avoid's lengthy drilling times

ECO system connector



Art. no.	Dimensions [mm] ^{a)}	Material	PU
975614	20 x 120 x 30	Plastic, black	10

^{a)} Height x length x width

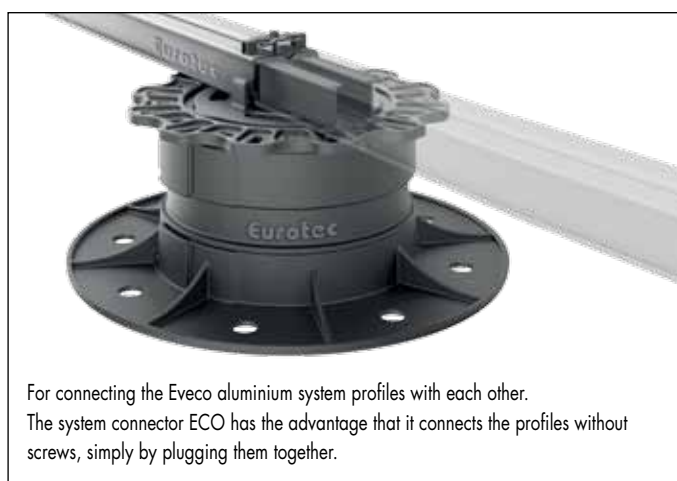

For connecting the Eveco aluminium system profiles with each other. The system connector ECO has the advantage that it connects the profiles without screws, simply by plugging them together.

Eveco corner connector

For Eveco aluminium system profiles

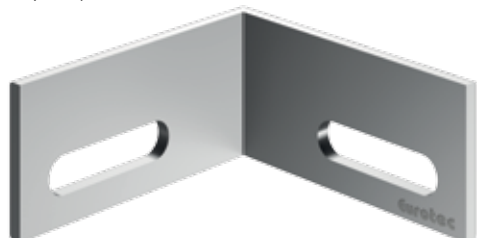

Art. no.	Dimensions [mm] ^{a)}	Material	PU*
975631	19 x 40 x 40	Aluminium	10

^{a)} Height x length x width

* Incl. 20 screws

Max. support spacing (L) for Eveco aluminium system profile without adjustable pedestals, e.g. on concrete foundations^{a)}

Payload [kN/m ²]	Centre distance e [mm] between profiles ^{b)}							
	300	350	400	450	500	550	600	800
2,0	800	750	750	700	700	650	650	600
4,0 ^{c)}	650	600	600	550	550	500	500	450
5,0 ^{d)}	600	550	550	500	500	500	450	450

^{a)} Indication of max. span at which the profile's deflection does not exceed L/300. Average board thickness of 25 mm with a specific weight of 7 kN/m³ (larch, pine, Douglas fir).

^{b)} e.g.: spacing between profiles = 550 mm; payload = 2,0 kN/m² → max. span of the profile = 650 mm.

^{c)} Payloads according to DIN EN 1991-1; roof terraces = 4 kN/m², patios for public use = 5 kN/m².

Max. support spacing L [mm] for Eveco aluminium system profile with adjustable pedestals^{a)}

Payload [kN/m ²]	BASE adjustable pedestals, perm. F = 2,2 kN							
	Centre distance e [mm] between profiles ^{b)}							
	250	300	350	400	450	500	550	600
2,0	800	750	700	650	650	600	600	600
3,0 ^{d)}	700	650	600	600	550	550	500	450
4,0 ^{c)}	650	600	550	550	500	450	400	350
5,0 ^{d)}	600	550	500	450	400	350	300	300

Payload [kN/m ²]	PRO adjustable pedestals, perm. F = 8,0 kN							
	Centre distance e [mm] between profiles ^{b)}							
	250	300	350	400	450	500	550	600
2,0	800	750	700	650	650	600	600	600
3,0 ^{d)}	700	650	600	600	550	550	550	500
4,0 ^{c)}	650	600	550	550	500	500	500	450
5,0 ^{d)}	600	550	500	500	500	450	450	450

^{a)} Indication of max. span at which the profile's deflection does not exceed L/300. Average board thickness of 25 mm with a specific weight of 7 kN/m³ (larch, pine, Douglas fir).

^{b)} e.g.: spacing between profiles = 550 mm; payload = 2,0 kN/m² → max. span of the profile = 600 mm.

^{c)} Load capacities according to DIN EN 1991-1; roof terraces = 4 kN/m², decks for public use = 5 kN/m².

^{d)} Load capacity according to SIA 261 for balconies and roof terraces private use = 3 kN/m².

Aluminium concrete bracket

For fixing to concrete

NEW
to our product range

Aluminium concrete bracket

Aluminium



Suitable for this:
EVO aluminium system profile,
EVO Light aluminium system profile,
Eveco aluminium system profile

Art. no.	Dimensions [mm] ^{a)}	Ø Round hole [mm]	Slotted hole [mm] ^{b)}	PU*
975661	19,75 x 22,75 x 30	8	20 x 4,5	10

^{a)} Height x length x width

^{b)} Length x width

*Delivery includes one 4,2 x 17 mm Thermofix screw.

The rock concrete screw for fixing to concrete is not included in the scope of delivery and must be ordered separately.

Instructions for use

The aluminium concrete bracket is fixed to the aluminium through the slotted hole using the 4,2 x 17 mm Thermofix screw supplied. The slotted hole can be used to compensate for material expansion of the aluminium.

The round hole is used for fixing to concrete with the 7,5 mm rock concrete screw hexagonal/hexagonal with flange.

Aluminium concrete bracket in conjunction with the EVO aluminium system profile



Aluminium concrete bracket in conjunction with the EVO Light aluminium system profile



Aluminium concrete bracket in conjunction with the Eveco aluminium system profile





Aluminium Deck Support System HKP

For bridging wider spans

One system, many advantages

- High load bearing capability
- Large support widths
- High dimensional stability and evenness
- Low dead load
- High flexibility
- High durability
- Attractive, clean enclosed frame
- Material savings

The deck support system comprises an aluminium substructure that allows spans of up to 3 m, depending on the desired loading capacity. The support system can therefore be tailored flexibly to meet a wide range of requirements. It is used especially on decks installed near to the ground in which only a few auxiliary supports are laid. Its versatile range of applications also includes elevated decks, load-bearing balconies and overhanging decks near to the ground.

The deck support system consists of two components that are joined together to form a closed, load-bearing system.



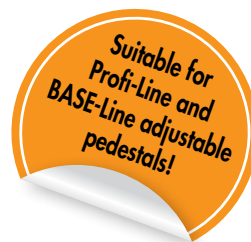

The two parts of the system form a complete deck substructure

Support-profile HKP



Art. no.	Dimensions [mm] ^{a)}	Material	PU
954669	100 x 4000 x 60	Aluminium	1

^{a)} Height x length x width

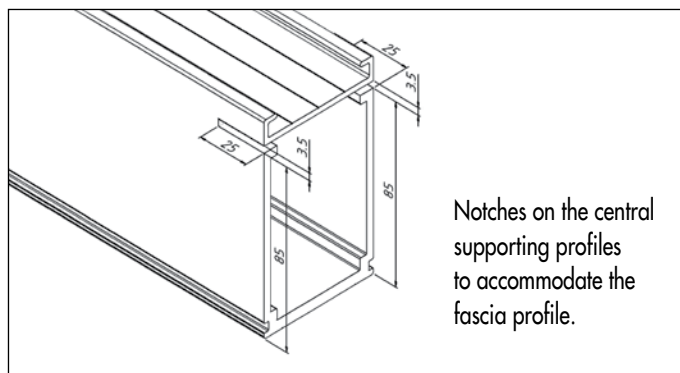

Fascia profile HKP



Art. no.	Dimensions [mm] ^{a)}	Material	PU
954668	104 x 4000 x 50	Aluminium	1

^{a)} Height x length x width

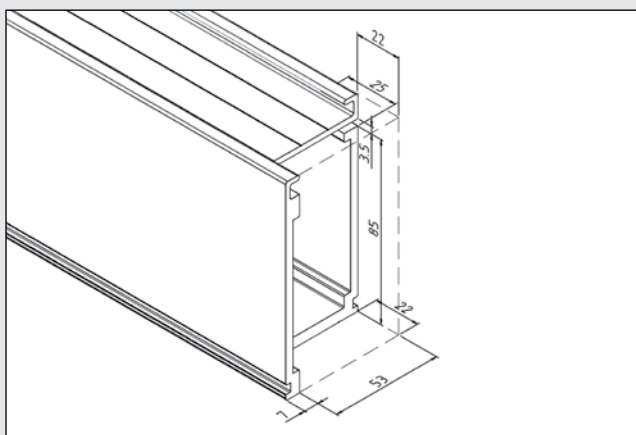
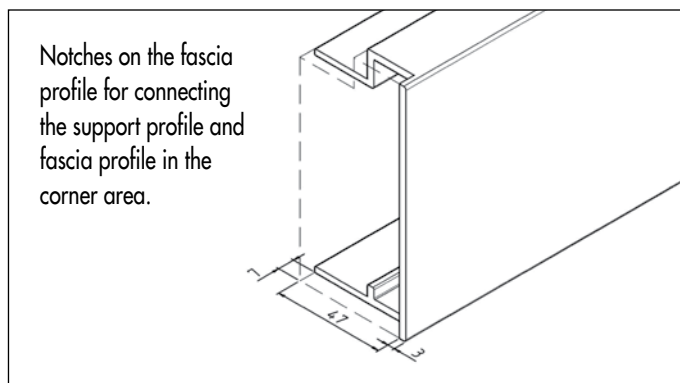

Notches on the fascia profile for connecting the support profile and fascia profile in the corner area.

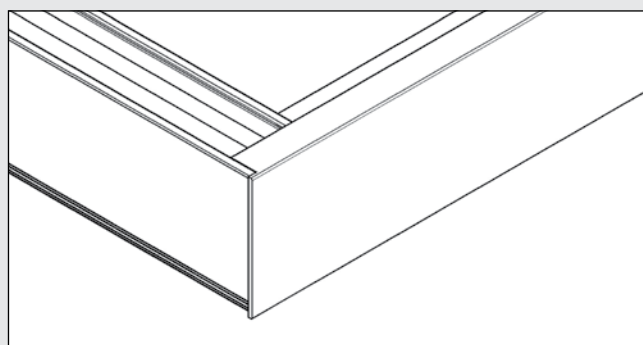

Aluminium support-profile connector

For support-profile HKP



Art. no.	Dimensions [mm] ^{a)}	Material	PU*
954670	74 x 250 x 50	Aluminium	1

^{a)} Height x length x width

*Incl. 8 drilling screw per connector



Note

The profile butt joint is only to be positioned directly above a post or support.



Note

Can be combined with the Twin system bracket for hidden fastening of deck boards.

BiGHTY drilling screw

Stainless steel, hardened

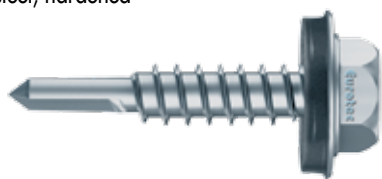

Suitable
for this



Stainless Steel

Art. no.	Dimensions [mm]	Spanner gap	Ø Washer	PU
945666	5,5 x 25	SW 8	Ø 16 mm	500

Properties

- For fastening wood to steel or steel to steel
- Special coating
- Stainless steel in accordance with DIN 10088 Washer A2 and EPDM
- Drilling capacity 5 mm

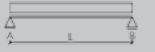
Maximum support distances L [mm] ^{a)} for supports made of concrete or steel

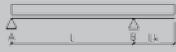
Bearing type	Payload kN/m ²	Axis clearance e [mm] of support profile HKP to one another ^{b)}						
		300	350	400	450	500	550	600
Single-span beam L 	2,0	3000	2750	2750	2500	2500	2500	2250
	3,0 ^{d)}	2750	2500	2500	2250	2250	2250	2000
	4,0 ^{d)}	2500	2250	2250	2000	2000	2000	2000
	5,0 ^{d)}	2250	2000	2000	2000	1750	1750	1750
Twin-span beam L [mm] 	2,0	3000	3000	3000	3000	3000	2750	2750
	3,0 ^{d)}	3000	2750	2500	2500	2500	2500	2250
	4,0 ^{d)}	2750	2500	2500	2500	2250	2250	2250
	5,0 ^{d)}	2500	2500	2250	2250	2000	2000	2000
Single-span cantilever beam L [mm] / L _k [mm] 	2,0	3000 / 1000	2750 / 1000	2750 / 1000	2500 / 1000	2500 / 1000	2000 / 1000	1750 / 1000
	3,0 ^{d)}	2500 / 1000	2500 / 1000	2500 / 750	2500 / 750	2500 / 750	2000 / 750	1750 / 750
	4,0 ^{d)}	1750 / 1000	1500 / 750	1500 / 750	1500 / 750	1500 / 750	1500 / 750	1500 / 750
	5,0 ^{d)}	1500 / 750	1500 / 750	1500 / 750	1500 / 750	1500 / 750	1250 / 750	1250 / 750



^{a)} Max. bearing clearances (L) for bearings with „direct support“ with payloads of 2, 3, 4 and 5 kN/m², with a mean board thickness of 25 mm and a board weight of 7 kN/m².

^{b)} If WPC boards are used, the axis clearance e between the profiles must not exceed 400 mm!

^{c)} Payloads in accordance with DIN 1055-3:2006, roof terraces = 4 kN/m², terraces in public = 5 kN/m².

^{d)} Load capacity according to SIA 261 for private balconies and roof terraces = 3 kN/m².

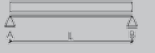
Maximum support distances (L) for adjustable feet of the PRO-Line (permitted F = 8,0 kN)

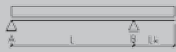
Bearing type	Payload kN/m ²	Maximum support distances L [mm] with the adjustable pedestals of the PRO-Line series with a HKP support profile ^{a)}						
		300	350	400	450	500	550	600
Single-span beam L 	2,0	3000	2750	2750	2500	2500	2500	2500
	3,0 ^{d)}	2750	2500	2500	2250	2250	2250	2000
	4,0 ^{d)}	2500	2250	2250	2000	2000	2000	2000
	5,0 ^{d)}	2250	2000	2000	2000	1750	1750	1750
Twin-span beam L [mm] 	2,0	3000	3000	3000	3000	3000	2750	2500
	3,0 ^{d)}	3000	2750	2500	2250	2000	1750	1750
	4,0 ^{d)}	2500	2250	2000	1750	1500	1250	1250
	5,0 ^{d)}	2000	1750	1500	1250	1250	1000	1000
Single-span cantilever beam L [mm] / L _k [mm] ^{d)} 	2,0	3000 / 1000	2750 / 1000	2750 / 1000	2500 / 1000	2500 / 1000	2000 / 1000	1750 / 1000
	3,0 ^{d)}	2500 / 1000	2500 / 1000	2500 / 750	2500 / 750	2500 / 750	2000 / 750	1750 / 750
	4,0 ^{d)}	1750 / 1000	1500 / 750	1500 / 750	1500 / 750	1500 / 750	1500 / 750	1500 / 750
	5,0 ^{d)}	1500 / 750	1500 / 750	1500 / 750	1500 / 750	1250 / 750	1250 / 500	1250 / 500

^{a)} Max. bearing clearances (L) for bearings with adjustable pedestals of the PRO-Line series with payloads of 2, 3, 4 and 5 kN/m², with a mean board thickness of 25 mm and a board weight of 7 kN/m² (larch, pine, Douglas fir).

^{b)} If WPC boards are used, the axis clearance e between the profiles must not exceed 400 mm!

^{c)} Load capacities according to DIN EN 1991-1; roof terraces = 4 kN/m², decks for public use = 5 kN/m².

^{d)} Lifting forces of up to 1 kN can be sustained on support A.

^{e)} Load capacity according to SIA 261 for balconies and roof terraces private use = 3 kN/m².

Note

This table provides an overview only of the load bearing capability.

The information on load bearing capability in the technical information must be noted!

Aluminium function strips / Aluminium function strips DiLo

The aluminium function strips from Eurotec offer special solutions for substructures of timber decks with a low assembly height.

Properties

- The profile impresses with its low assembly height; for example:
profile height 29 mm + board 24 mm = Total height 53 mm.
- This low height means the profile is excellently suited to the construction of timber decks that are to be built on existing stone patios, balconies or roof terraces.
- The aluminium is dimensionally stable, does not rust and is extremely weather-resistant. These are key advantages over timber substructures.
- The small supporting surface is ideal for allowing water to run off and prevents the screw from shearing off.
- The self-adhesive cork insert is free of PAHs and ensures good footfall sound damping on the underside of the profile.
- The aluminium function strip is available in two versions so that – here, too – one can choose between visible and hidden screw connections on a case-by-case basis.

Hidden fastening



Visible fastening



Aluminium function strip



Free of PAHs
(hazardous plasticisers in rubber).

Art. no.	Dimensions [mm] ^{a)}	Material	PU
945510	29 x 1750 x 34	Aluminium	1

^{a)} Height x profile length x width

For the direct attachment of decking boards of 21 - 25 mm thickness, see Profile drilling screw and Wing-tipped profile drilling screw (p. 88).



Art. no.	Dimensions [mm] ^{a)}	Material	PU*
945535	29 x 2240 x 34	Aluminium	1

^{a)} Height x profile length x width

*Cork pads are not included with this product.

See DiLo drilling screws (p. 59) for hidden fastening of deck boards with a thickness of 20 - 30 mm.

DiLo aluminium function strip



Holes: 5,1 mm
Distance from hole to hole: 20 mm
Distance from edge to first hole: 10 mm

Accessories for aluminium function strip / aluminium function strip DiLo

Procedure for hidden fastening of deck boards to DiLo aluminium function strips:

- 1 Cut the DiLo aluminium function strips and deck boards to the lengths you require.
- 2 Lay the cut boards down so that the rear side is facing upwards.
- 3 Align the boards with a uniform joint spacing on a leveled subsurface. Use the Eurotec spacer for this.
- 4 Lay the DiLo aluminium function strips backwards onto the boards (at least two DiLo aluminium function strips per element).
- 5 Fasten each strip in place by screwing two DiLo drilling screws (Ø5x28,5; Ø5x33,5 or Ø5x38,5 mm) into the board for each intersection point (of board and substructure) through the prefabricated drill holes in the strip.
- 6 Stick the cork pads into the DiLo aluminium function strip so that almost the entire surface is used for support.
- 7 Finally, just turn the finished element over and position it. Done.



Cork pad with adhesive tape

For DiLo aluminium function strip

Suitable for this



Art. no.	Dimensions [mm] ⁰⁾	PU
945331	17 x 90 x 28	100

⁰⁾ Height x length x width



Pull off the protective film

DiLo drilling screw

Hardened stainless steel

Suitable for this



- Limited resistance to acid
- 10 years experience without corrosion problems with suitable woods
- Not suitable for woods containing high amounts of tanning agents, such as cumarú, oak, merbau, robinia, etc.
- Not suitable for use in chlorous atmospheres
- Stainless steel in accordance with DIN 10088

Stainless Steel

Art. no.	Dimensions [mm]	Drive	Board thickness	PU*
111860	5,0 x 28,5	TX25 •	at least 20 mm	200
111861	5,0 x 33,5	TX25 •	at least 25 mm	200
111862	5,0 x 38,5	TX25 •	at least 30 mm	200

* Incl. 1 Bit

Overview of End Profiles

End profiles for single point support

- For terraces with flagstone flooring
- Visually attractive border
- Easy assembly
- Water drains through holes in profile

Terrace edge profile for aluminium substructures

- Aesthetic finish of terraces with flagstone flooring
- Versatile applications
- For slab thicknesses ≤ 40 mm

Aluminium screen

- High quality terrace edge
- Provides the ability to match the entire edge structure
- Easy assembly
- Freely combinable with all standard gutter systems

End profiles - Eaves

- Screen with integrated water drain
- Available in 2 heights
- Easy assembly
- Freely combinable with all standard gutter systems





Deck fascia board mount

- Provides a visually pleasing Fascia
- Can be used with the PRO M and L adjustable pedestals



Fascia profile

- For a head end or the butt joint of the decking
- Ensures non-slip surface even in wet conditions
- Flat geometry prevents tripping hazards
- Resistant to weather, UV exposure, insects and rot



DrainTec – drainage grate

- For draining façade and terrace surfaces
- Can be combined with the Eurotec product range to create elevated deck areas
- For creating barrier-free, wheelchair-friendly transitions
- Also suitable for direct mounting on load-bearing foundations

Deck end profiles for single point support

Our deck end profile for single point support can be used to achieve a visually attractive border on decks with stone slab flooring. Our product is used in the field of single point support in conjunction with our PRO M - XL adjustable pedestals.

The border consists of two parts: the upper part, which is placed on the head of the PRO adjustable pedestal, and the lower part, on which the adjustable pedestal is positioned.

End profiles for single point support



Art. no.	Name	Dimensions [mm] ^{a)}	Material thickness [mm]	Material	PU
975637	top	37,5 x 2000 x 215,5	3	Aluminium	1
975638	bottom	23 x 2000 x 240,5	3	Aluminium	1

^{a)} Height x length x width

Note: for slab thicknesses ≤ 40 mm

During the installation of an outdoor deck in combination with adjustable pedestals as direct supports, we recommend to build a frame around the outer perimeter by using our end profiles for stand alone support, to prevent the covering surface from moving under live-load.



Advantages

- Visually attractive border
- Easy assembly
- Water drains through holes in profile

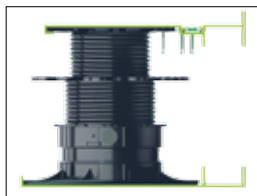

External corner deck edging set

For external corners in combination with top and bottom end profiles

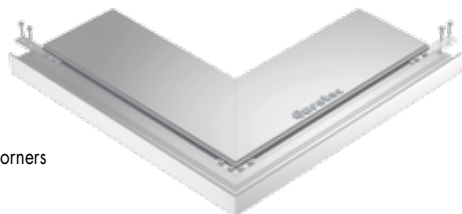

Set consists of

- Left and right external corners
- 2 profile connectors
- 1 corner connector
- 12 drilling screws 4,8 x 25 mm

Art. no.	Dimensions [mm]	Material	PU
975646	500 x 500	Aluminium	1

Inside corner deck edging set

For inside corners in combination with end profiles

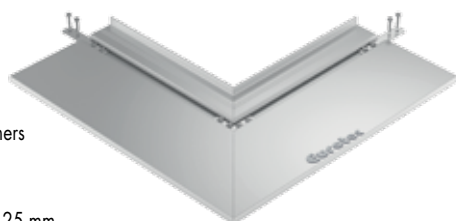

Set consists of

- Left and right inside corners
- 2 profile connectors
- 1 corner connector
- 12 drilling screws 4,8 x 25 mm

Art. no.	Dimensions [mm]	Material	PU
975645	500 x 500	Aluminium	1

Corner connector deck edging set

For 90° corner connections in the end profiles



Set consists of

- 2 corner connectors
- 8 drilling screws 4,8 x 25 mm

Art. no.	Dimensions [mm] ^{*)}	Material thickness [mm]	Material	PU
975641	50 x 50 x 20	2	Aluminium	2

*) Height x length x width

Profile connector deck edging set

For extending the end profiles

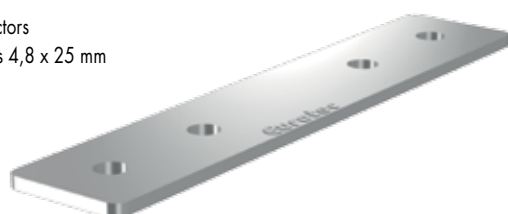

Set consists of

- 2 profile connectors
- 8 drilling screws 4,8 x 25 mm

Art. no.	Dimensions [mm]	Material thickness [mm]	Material	PU
975642	100 x 20	2	Aluminium	2

Deck end profile for aluminium substructures

The Eurotec deck end profiles for aluminium substructures deliver a visually attractive border on decks with stone slab flooring in combination with the Profi-Line adjustable pedestals and the EVO aluminium system profile.

The system consists of two end profiles, which enclose the deck's upper and lower edges respectively.

End profiles for aluminium substructure

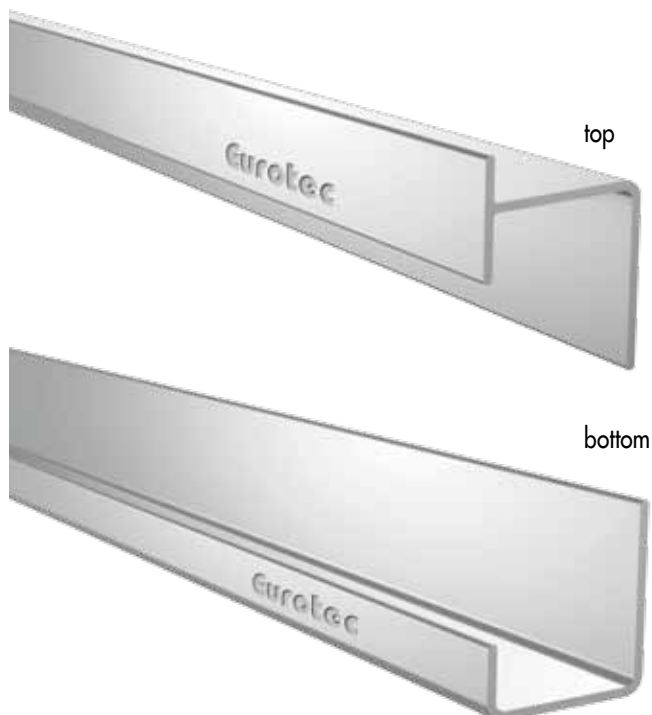

Art. no.	Name	Dimensions [mm] ^{a)}	Material thickness [mm]	Material	PU
975639	top	61,5 x 2000 x 45	2,5	Aluminium	1
975640	bottom	50 x 2000 x 45	2,5	Aluminium	1

^{a)} Height x length x width

Note: for slab thicknesses ≤ 40 mm

Drawing of top profile

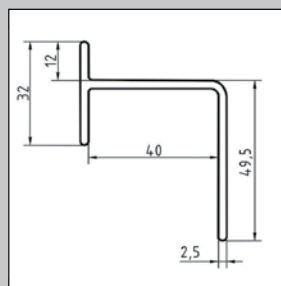

Drawing of bottom profile

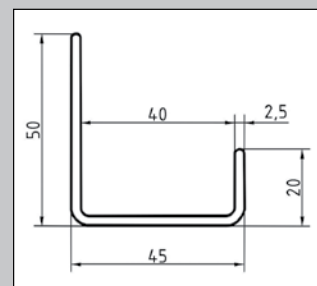

Advantages

- Visually attractive border
- Versatile applications

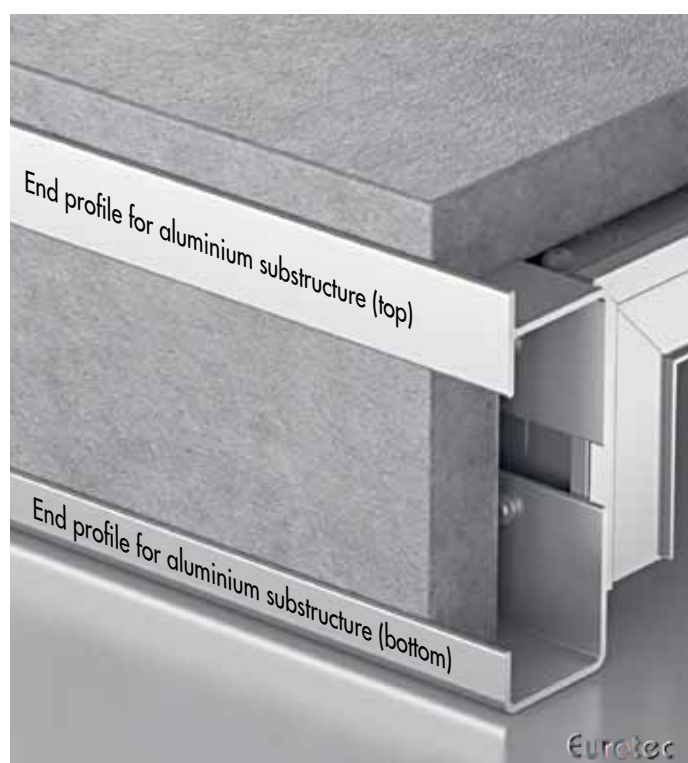
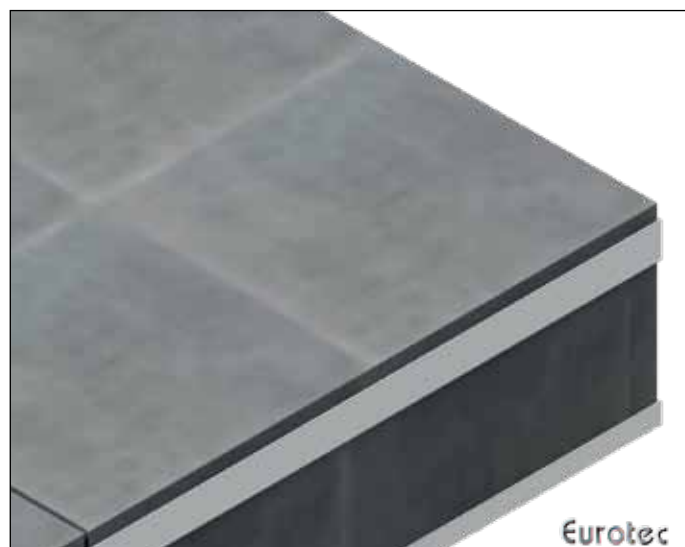

Notes

The product only includes the particular aluminium end profiles.
All other components must be ordered separately. Per fastening, these include:
EVO aluminium system profiles, 90° EVO joint, EVO corner connector and
6x BiGHTY 4,8 x 25 mm drilling screws (art. no. 954090-50, PU: 50).

(4x for the 90° EVO joint and 1x each for the connections to the top and bottom deck edging end profiles).

For slab thicknesses of less than 40 mm, the resulting free space must be filled with compression seal tape.

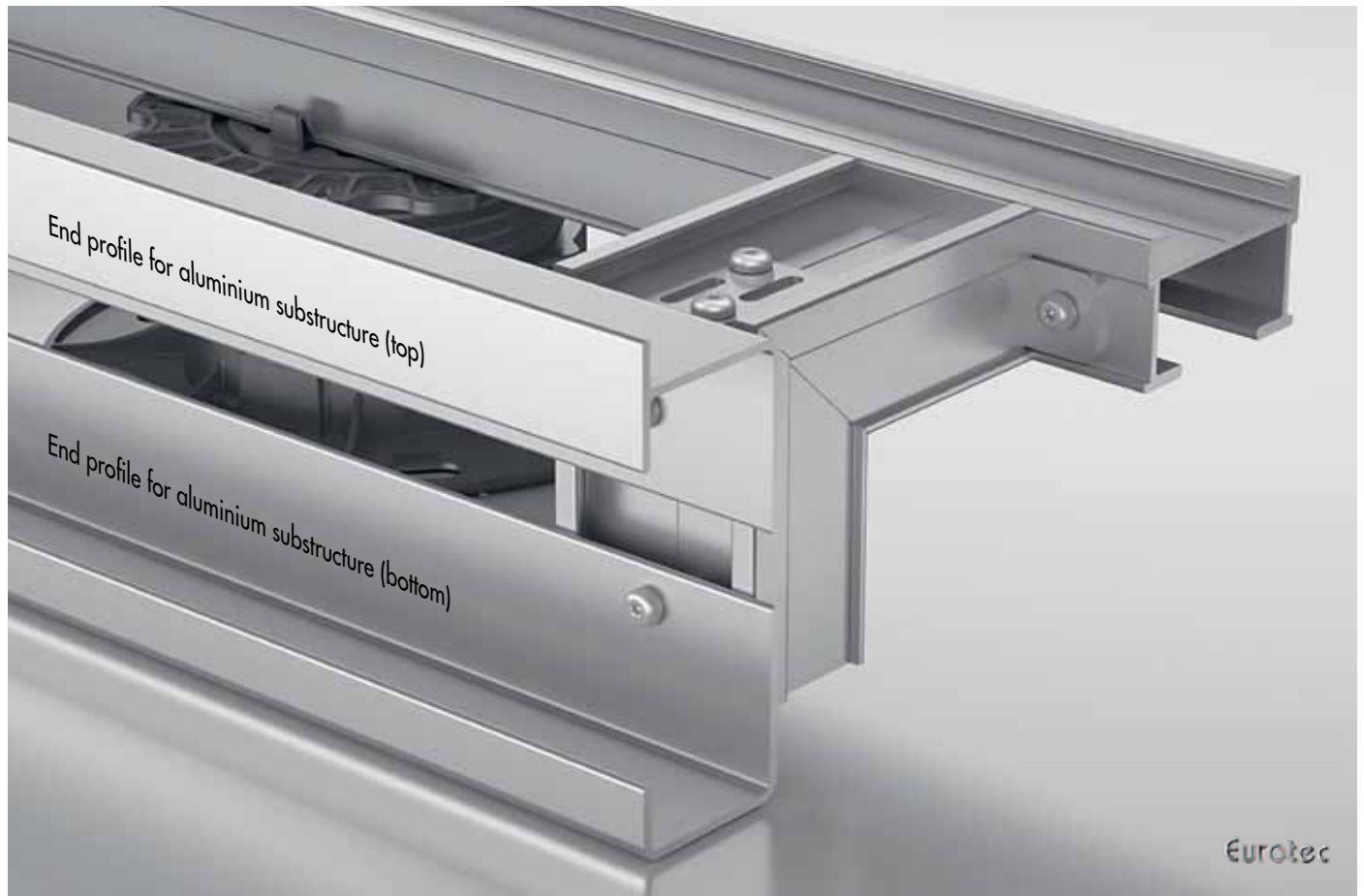

Aluminium cover

The aluminium cover can be combined with the tops of the terrace edge profiles for an aluminium substructure and single bearing or with the stone-edge clip to a high-quality terrace edge.

Aluminium cover

Art. no.	Dimensions [mm] ¹⁾	Material thickness [mm]	Material	PU
975655	116 x 2000 x 7	2	Aluminium	1

¹⁾ Height x length x width



Advantages

- Easy assembly
- Flexible border design
- It is possible to match the complete edge structures together
- Can be combined with all standard gutter systems/eaves fascia



Eurotec

Aluminium eaves

The aluminium eaves offers an additional opportunity to form the terrace edge. It is available in 3 cm and 5 cm in height.

The aluminium eaves forms the lower part or the entire panel for smaller

heights. Combined with the aluminium cover, the side openings can be closed.

Aluminium eaves



Advantages

- Easy assembly
- Elegant view
- Flexible border design
- It is possible to coordinate the complete edge structure
- Freely combinable with all standard gutter systems
- The lower sheets are enclosed within the sealing
- Integrated water drainage

Art. no.	Name	Dimensions [mm] ¹⁾	Material thickness [mm]	Material	PU
975653	Aluminium eaves 3 cm	72 x 2000 x 104	1,8	Aluminium	1
975654	Aluminium eaves 5 cm	92,8 x 2000 x 104	1,8	Aluminium	1

¹⁾ Height x length x width



Deck fascia board mount

The Eurotec deck fascia board mount can be used with the PRO M and L adjustable pedestals. It was developed to allow users to create a visually attractive border on decking.

The deck fascia board mount consists of a base plate and a side bracket. For assembly purposes, the side bracket can be separated into two individual parts: the Clip and the Fix-Clip.

Deck fascia board mount

Set incl. base plate, side bracket and screws

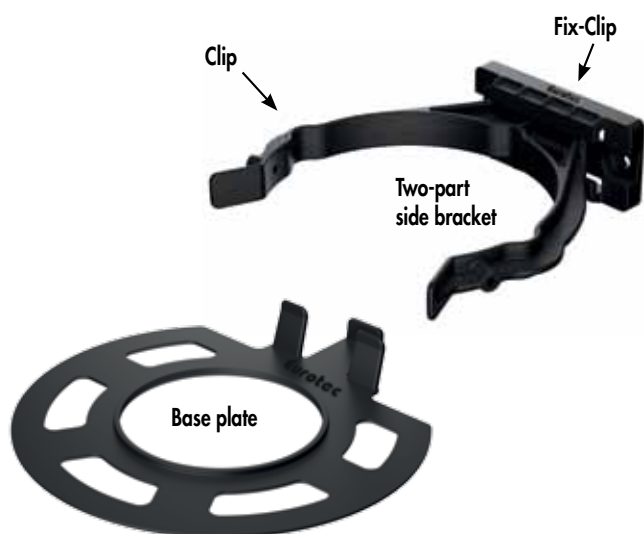

Art. no.	Set consists of	PU*
946068	Base plate and Two-part side bracket	16

* Delivery includes screws



Example application for mounting of a timber deck fascia using the PRO L adjustable pedestal.

Cover profile

For edge and end cover of the decking

The area of application of the new cover profile is the head end or the butt joint of the decking. Due to the specific surface, the screen profile is able to guarantee no risk of slipping even in wet conditions.

Thanks to the flat geometry, the cover profile does not represent a tripping hazard. Our cover profile can be freely combined with all commercially available decking boards.

Cover profile



Art. no.	Length [mm] ¹⁾	Material thickness [mm]	PU
975651	27,5 x 2400 x 37,5	2,5	1

¹⁾ Height x length x width

Advantages

- Quick and easy assembly
- Freely combinable with all available decking boards
- Ensures a non-slip surface even in wet conditions
- Flat geometry prevents tripping hazards
- Resistant to weather, UV exposure, insects and rot

Application information

Fixing is done with countersunk screws ($\varnothing \leq 4$ mm) through the prefabricated holes, which are arranged at an axis-centre distance of 20 cm. Due to the small edge distance of the screw, it is recommended that you pre-drill!



DrainTec – aluminium drainage grate

The construction of an open-air space is accompanied by an extensive set of requirements.

In developing the DrainTec drainage grate, we turned our attention to the topic of: **drainage for façade and deck surfaces**. The DrainTec drainage grate focuses on the detailed aspects of how these surfaces connect to building openings, e.g. areas that connect to doors, or transitions from vertical façade surfaces to horizontal deck surfaces.

Its special geometry allows it to “trap” the rain so that the water falls directly onto the weatherproof layer, or into the gutter, without covering the door element or the façade cladding with reflected water (backsplash). Heavy rain is drained off in a controlled manner. The flat geometry (21 x 140 mm) allows the grate to be combined with standard deck boards or fine stoneware slabs.

DrainTec – drainage grate



Art. no.	Name	Dimensions [mm] ^{a)}	Material	PU
975634	DrainTec – drainage grate	21 x 4000 x 140	Aluminium	1

^{a)} Height x length x width

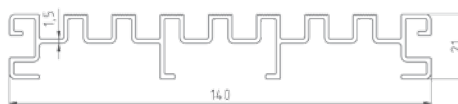

DrainTec Clip



Art. no.	Name	Dimensions [mm] ^{a)}	Material	PU*
975635	DrainTec Clip	16,5 x 144 x 20	Stainless steel	2

^{a)} Height x length x width

*Comes supplied with screws

Used to attach drainage grate by simply clicking into place and allows subsequent removal of drainage grate.



Without DrainTec

the reflected rainwater splashes onto the door element or façade cladding



With DrainTec

the rain is drained off in a controlled manner and the rainwater flows directly into the foundation

The aim is to ensure permanent drainage without dammed-up water.

- Can be combined with the Eurotec product range to create elevated deck areas
- As an inspection and cleaning fitting

- Even for low door-joint heights
- For creating barrier-free, wheelchair-friendly transitions
- Also suitable for direct mounting on load-bearing foundations

DrainTec Base

The DrainTec Base is the ideal addition to our DrainTec Drainage Grate.

Thanks to the DrainTec Base, our DrainTec Drainage Grate can now also be used at ground level on gravel, sand and other substrates.

Through the angular perforations in the middle of the base, the base can be combined with our adjustable pedestals from the PRO-Line series.

The Click Adapter 60 is required for this. By using an additional screw, the base can be fixed onto the adjustable pedestal. The base can be used as part of standalone support and with aluminium substructures.

DrainTec Base



Art. no.	Name	Dimensions [mm] ^{a)}	Material	PU
975658	DrainTec Base	20 x 2400 x 144	Aluminium	1

^{a)} Height x length x width

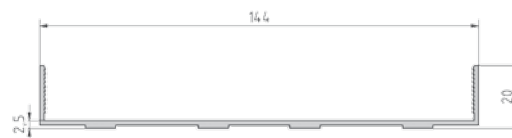

Advantages

- Supports drainage of decking
- Easy to clean base
- Does not require any additional substructure when laying on bulk material
- Compatible with classic substructures made of wood as well as with our modern aluminium system profile and the deck support system HKP
- Easy to lay
- Weather-resistant
- Compatible with adjustable pedestals PRO S – PRO XL



Instructions for use

When using on an aluminium substructure we strongly recommend the use of our MaTre band (product no. 945319). This serves to prevent noise when treading on the structure.

Aids

For laying deck boards

HIDDEN FASTENING

Fixing the deck without visible screw heads

Deck boards can be fastened in different ways, depending on the type of wood. We provide innovative solutions that enable your individual requirements and wishes for fastening your deck boards.

Advantages

- Indirect/hidden fastening solution
- Compatible with different Eurotec aluminium system profiles
- Uniform joint spacing is guaranteed
- Supports constructive timber protection
- Weather-resistant



© NATURinFORM

Hidden fastening



Eurotec

Twin system clip

Hidden fastening to aluminium substructure

Twin system clip

For hidden fastening of decking with grooved sides and made of dimensionally stable timber types (e.g. larch, thermally modified timber) or WPC to:

- EVO aluminium system profile
- EVO Slim aluminium system profile (please consider the note)
- HKP deck-support system

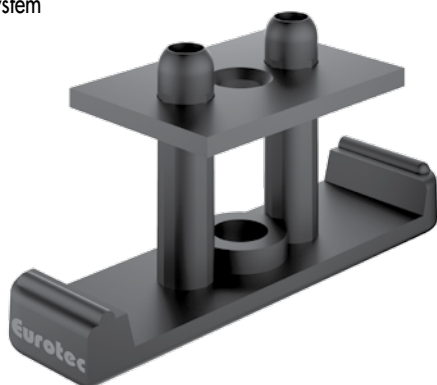

Product description

The Twin aluminium system clip is inserted between two wooden boards before being secured within the board groove using a stainless steel clamping plate. The clamping plate is attached to the aluminium substructure using a drilling screw between the joints. The spacer domes ensure uniform joint spacing from board to board.

Advantages

- Indirect/hidden fastening solution
- Individual boards can be adjusted and replaced at any time
- Compatible with Eurotec's EVO/EVO Slim aluminium system profiles and the HKP deck-support system
- Uniform joint spacing of approx. 6 mm
- Supports constructive timber protection
- Weather-resistant

Art. no.	Dimensions [mm] ^{a)}	Material	PU*
945959	26 x 55 x 15	Plastic, black	200

clamping plate	2 x 30 x 20,5	A2 stainless steel, black
----------------	---------------	---------------------------

^{a)} Height x length x width

* Comes supplied with screw Ø 5 x 50 mm



The Twin system clip is suitable for boards with the following groove geometry:

Groove depth, D:	Groove width, W:	Groove wall thickness, T:
≥ 7,5 mm	≥ 2,0 mm	≥ 2,0 – 12,0 mm

Where applicable, the manufacturer/timber supplier must establish whether the timber type is suitable.

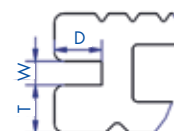

Alternative screw for the use of the EVO Slim profile:

Art. no.	Dimensions [mm] ^{a)}	Material	PU
111878	5 x 35	Stainless steel, hardened	100
111882	5 x 30	Stainless steel, hardened	100

^{a)} Height x length x width

Note:

If the Twin system clip is intended to be used in combination with the **Aluminium System Profile EVO Slim**, a shorter screw needs to be ordered separately. When the supplied screw Ø 5 x 50 mm is used there is the risk, that components below the EVO Slim, such as waterproofings, may get damaged.

It is necessary to take a look at our product data sheet available on www.eurotec.team or to get in contact with our technical support.

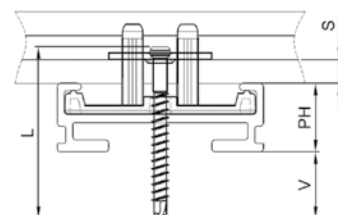

EVO Light system clip

Hidden fastening to aluminium substructure

Properties

- For invisible attachment of grooved boards on: EVO Light aluminium system profile
- Suitable for specific groove geometry: See previous page
- For questions regarding groove geometry, always contact your local specialist timber dealer
- Time-saving and easy installation
- Automatically predefined joint spacing of 6 mm
- Individual boards can be adjusted or replaced at any time
- Supports constructive timber protection
- Weather-resistant

Hidden fastening with the EVO Light system clip



EVO Light system clip

Straight



EVO Light system clip, straight is suitable for boards with the following groove geometry:

Groove depth, D:	Groove width, W:	Groove wall thickness, T:
≥ 7,5 mm	≥ 2,0 mm	≥ 2,0 - 9,0 mm

Where applicable, the manufacturer/timber supplier must establish whether the timber type is suitable.

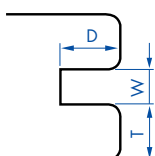

Art. no.	Dimensions [mm] ^{a)}	Material	PU*
946029	21 x 24 x 15	Plastic, black	200

clamping plate	Dimensions [mm]	Material	PU*
	1,5 x 30 x 22	A2 stainless steel	

^{a)} Height x length x width

* Comes supplied with screw



Note

In case of deviations of the groove thickness, the screw length may change! Please contact our technical department.

EVO Light system clip

Bent



EVO Light system clip, bent is suitable for boards with the following groove geometry:

Groove depth, D:	Groove width, W:	Groove wall thickness, T:
≥ 7,5 mm	≥ 4,0 mm	≥ 2,0 - 9,0 mm

Where applicable, the manufacturer/timber supplier must establish whether the timber type is suitable.

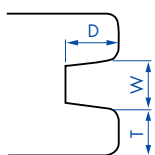

Art. no.	Dimensions [mm] ^{a)}	Material	PU*
946034	21 x 24 x 15	Plastic, black	200

clamping plate	Dimensions [mm]	Material	PU*
	1,5 x 30 x 21,1	A2 stainless steel	

^{a)} Height x length x width

* Comes supplied with screw



Note

In case of deviations of the groove thickness, the screw length may change! Please contact our technical department.

ECO system clip

Hidden fastening to aluminium substructure



© NATURinFORM

ECO system clip

For Evenco aluminium system profiles

Properties

- For hidden fastening of boards with grooved sides
- Only limited suitability for selected narrow tropical timbers (always consult your local specialist timber dealer)
- Simple, time-saving assembly
- Joint spacing automatically predefined
- Individual boards can be adjusted or replaced at any time

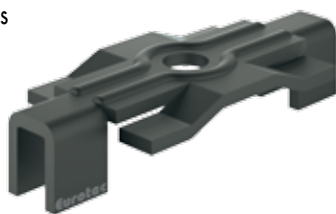

Art. no.	Dimensions [mm] ¹⁾	Material	PU*
975600-250	7,2 x 37 x 16	Stainless steel, black	250

¹⁾ Height x length x width

* Comes supplied with screw



The ECO system clip is suitable for boards with the following groove geometry:

Groove depth, D:	Groove width, W:	Groove wall thickness, T:
≥ 5,5 mm	≥ 2,8 mm	≥ 5,0 - 7 mm

Where applicable, the manufacturer/timber supplier must establish whether the timber type is suitable.

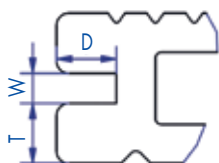

Deck gliders

Hidden fastening of deck boards

The deck glider also creates a 10 mm gap between the substructure and the deck boards to prevent shearing of the stainless steel screws, for use with low-swelling and low-shrinkage timbers (see p. 87).

However, in contrast to Distance strips 2.0, the boards are fastened indirectly, i.e. screw heads cannot be seen on the surface of the deck. The gliders fulfill all criteria for fastening both wood and composite boards.



The deck glider comes supplied with Thermofix screws made of hardened stainless steel. If required, you can additionally buy the glider screws in A2 or A4 stainless steel.



Installation instructions for the deck glider

To fasten the boards in place, the gliders are first screwed onto the underside of the boards and then screwed onto the substructure from above. This fastening type avoids direct connections to the substructure. The deck boards therefore have greater freedom of movement (via the deck glider).

Per glider, we recommend using two screws for fastening the glider onto the board and two screws for fastening the glider onto the substructure. For the Mini deck glider, you should use two screws for fastening the Mini deck glider onto the board and one screw for fastening it to the substructure. The deck gliders are suitable for boards with a width of 80 to 155 mm and a thickness of 20 to 30 mm. The Mini deck gliders are suitable for boards with a width of 90 mm to 100 mm and a minimum board thickness of 20* mm.

* If the 4,2 x 22 mm Thermofix screw is used

Deck gliders

Suitable for hidden deck-board fastening



Art. no.	Dimensions [mm] ^{a)}	Quantity* [piece / 10 m ²]	Material	PU
944830	10 x 190 x 20	123	Hard plastic	200

^{a)} Height x length x width

* Clearance of bearing beams = 600 mm, board width = 145 mm, Joint dimension = 5 mm (depending on type of timber). Please use decking multi angles or the StarterClip for the first and last bearing beams, and for the board butts.

Each deck glider includes 4 Thermofix screws made of hardened stainless steel.
If required, you can additionally buy the glider screws in A2 or A4 stainless steel.

Mini deck glider

Suitable for hidden deck-board fastening

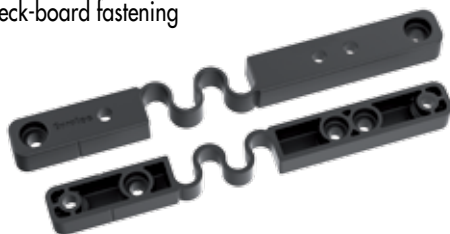

The Mini deck glider is used for narrow deck boards with a width of 90 to 100 mm.

Art. no.	Dimensions [mm] ^{a)}	Quantity* [piece / 10 m ²]	Material	PU
944767	10 x 140 x 14	200	Hard plastic	200

^{a)} Height x length x width

* Clearance of bearing beams = 500 mm, board width = 90-100 mm, Joint dimension = 5 mm (depending on type of timber). Please use decking multi angles or the StarterClip for the first and last bearing beams, and for the board butts.

Each Mini deck glider includes 3 Thermofix screws made of hardened stainless steel.
If required, you can additionally buy the glider screws in A2 or A4 stainless steel.

Glider screw

A4



- Limited resistance to acid
- Suitable for use with woods containing tanning agents such as cumarú, oak, merbau, robinia, etc.
- Suitable for saline atmospheres
- Not suitable for use in chlorous atmospheres

Stainless Steel

Art. no.	Dimensions [mm]	Drive	PU
944927	4,2 x 24	TX20 •	100

Thermofix screw

With drill point, stainless steel, hardened

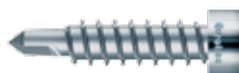

Stainless Steel

Art. no.	Dimensions [mm]	Drive	PU
945969	4,2 x 22	TX20 •	100

Decking multi angles

Hidden screwing of start/end deck boards

Decking multi angles

For hidden fastening of start/end deck boards



Art. no.	Material	Art. no.	PU*
975584	Hard plastic		10

*40 system screws are included in the scope of delivery

If you would like to fix the start/end decking without a visible screw, use the decking multi angle or the StarterClip.

Decking multi angles enable a clean and hidden conclusion when deck boards are laid.



StarterClip

Hidden screwing of start / end deck boards

StarterClip

For hidden fastening of start/end deck boards

Art. no.	Material	PU*
975591	Hard plastic	10

*40 system screws are included in the scope of delivery



If decking multi angles cannot be used, e.g. because they cannot be screwed in from one side (house wall or brickwork), Eurotec has developed the StarterClip, which is the ideal solution in situations like this.

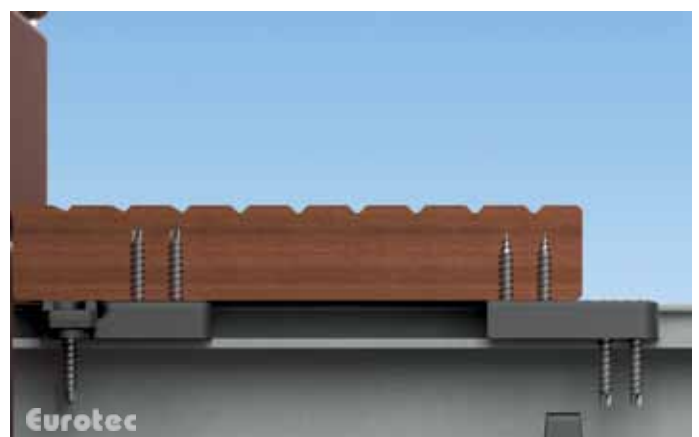
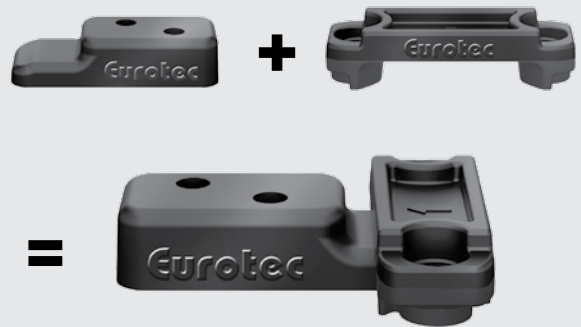

T-Stick

Hidden fastening of deck boards

The T-Stick is inserted between two wood boards and fastened in the board groove with a steel plate. The result is an attractive wood surface without visible screw heads. The board clearance is maintained automatically by the T-Stick. The clearance of 9 mm to the substructure enables good ventilation, and this prevents waterlogging. The service life is therefore affected positively. If Eurotec's installation specifications are complied with, the T-Stick enables the boards to be adjusted easily before they are screwed down firmly. After fastening, the boards are absolutely firm. If a board has to be replaced, the system makes this possible even after the deck has been completed.

Fast installation

The T-Stick fastening system can be used immediately. Using the StarterClip allows hidden screw connections even for the start and end boards.

No pilot drilling is needed.

Once the start board has been laid, the next board is put into position, aligned and fixed. Insert the T-Stick with the plate into the wood board groove, screw the screw in slightly to fix. After fixing the board, you can screw it in place.

Make sure that your cordless screwdriver's torque is set correctly so that you never over-tighten the screws.

T-Stick

Advantages

- Boards can be replaced easily even after the deck has been completed!
- Realigning individual boards is possible at any time.
- When they are fixed, the boards have a safe and firm seat.

Note

Only suitable for dimensionally stable timbers and WPC.

Material description

The T-Stick comprises a glass fibre reinforced, weather-resistant plastic cross with a stainless steel plate and a stainless steel screw.

There are two design variants:

- 1) **Stainless steel A2 plate** for normal external use.
- 2) **Stainless steel A4 plate** for chlorous and saline atmospheres (e.g. seawater) and in woods with increased tanning acid content (e.g. Robinia, oak).

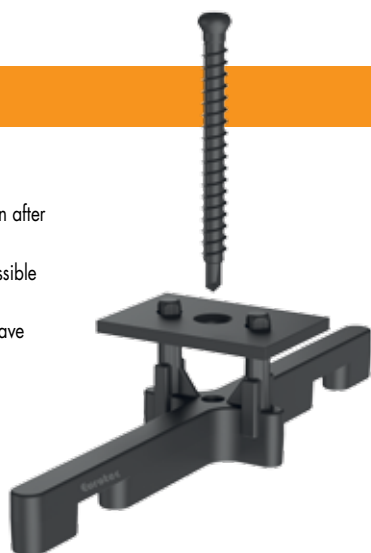

Art. no.	Stainless steel plate*	Material	PU**
111857	A2	Plastic, black	125

* Stainless steel A4 plate available on request.

** Supplied with a drilling screw, which is suitable for wooden and aluminium substructures with a thickness of up to 3 mm.

The T-stick is suitable for planks with the following groove geometry:

Groove depth, D:	Groove width, W:	Groove wall thickness, T:
≥ 7,5 mm	≥ 2,5 mm	≥ 5,5 – 12,5 mm

Where applicable, the manufacturer/timber supplier must establish whether the timber type is suitable.

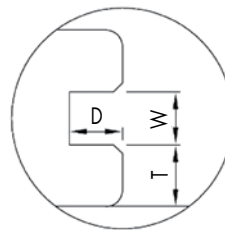

Using the T-Stick

A wood deck without visible screw heads!



Start with the decking multi angle or StarterClip.



Align and fix the next board, screw down with the T-Stick until all boards are fastened.



The last board can then be fastened with the StarterClip.



This fastening system is suitable exclusively for deck boards with a side groove.

Drill Tool 50X

The optimal screw-in aid

The drill tool 50X is a drilling jig for the invisible attachment of decking. Decking boards can only be fastened non-visibly with this tool. Thus, no screw heads are visible on the terrace surface.

The screws are evenly screwed in at a 50 ° angle thanks to the specified fixing points and thus optimally placed.

The distance done on the drill tool 50X automatically ensures a uniform gap distance of 6 mm between the individual planks.



Drill Tool 50X



Advantages

- Quick and easy decking installation
- Ensures a uniform joint pattern
- Fixing points are predefined

Instructions for use

With the help of the drill tool 50X decking can be non-visibly fixed.

For optimal installation without damaging the decking we recommend our 50X deck screw in A2 4,2 mm x 60 mm, 50X long-bit 82 mm TX15 and the 50X step drill 3,3 mm to 4,5 mm.

For decking thicknesses ≥ 21 mm and decking widths of 110 mm - 150 mm.

Important: You need to ask the manufacturer or supplier whether the board is suitable for this type of attachment.

Art. no.	Dimensions [mm] ¹⁾	PU
499985	87 x 215 x 30	1

¹⁾ Height x length x width

50X deck screw

A2

Stainless Steel

Art. no.	Dimensions [mm]	PU
905514	4,2 x 60	250

50X long-bit

82 mm



Art. no.	Size	PU
499985-Bit	TX15 •	1

50X step drill

Art. no.	Material	PU
499985-Bohrer	Carbide	1

Eurotec Basic Shop

Everything at a glance



The Basic Shop is the cost-effective and space-saving alternative for selling the Eurotec 50X drill tool products.

Equipped with

- 50X deck screw
- 50X step drill
- 50X long bits
- 50X drill tool

The shelf has the following dimensions:

Height 1750 mm, width 338 mm, depth 500 mm

V-Clip

Hidden fastening of deck boards

V-Clip

NEW

to our product range



Advantages

- Indirect/hidden fastening solution
- Compatible with classic substructures made of wood as well as aluminium
- Uniform joint spacing of 7 mm

Note

Only suitable for the fastening of asymmetric grooved decking made of dimensionally stable timber types or WPC.

The stainless steel Eurotec V-Clip is suitable for the fastening of asymmetric grooved decking made of dimensionally stable timber types or WPC on timber substructures.

Make sure that your cordless screwdriver's torque is set correctly so that you never over-tighten the screws.

Art. no.	Dimensions [mm] ^{a)}	Material	PU*
111885	32,3 x 22,7 x 9,4	Stainless steel A2	250

a) Length x width x height

* Comes supplied with screw Ø 4,2 x 25 mm and 1 Bit/PU

The V-Clip is suitable for planks with the following groove geometry:

Groove depth:	Groove width:	Groove wall thickness:
≥ 8,2 mm	≥ 2,5 mm	≥ 8,0 - 10,0 mm

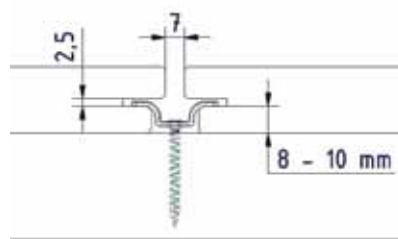

Using the V-Clip

A wood deck without visible screw heads!

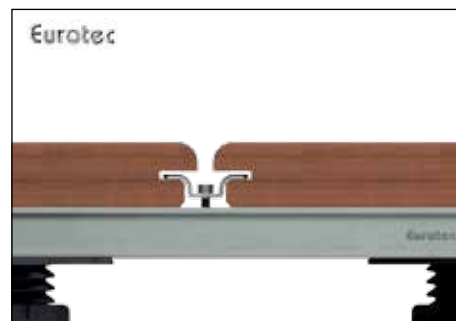
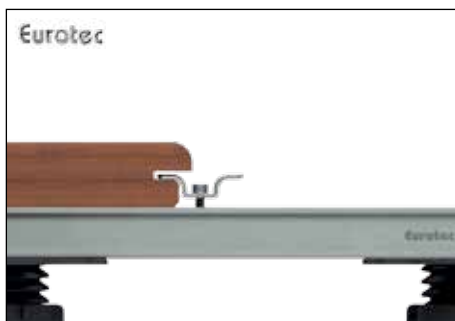

Accessories

For decking installation



VISIBLE FASTENING

Fixing the decking with visible screw heads

Deck boards can be fastened in different ways, depending on the type of wood. We provide innovative solutions that enable your individual requirements and wishes for fastening your deck boards.

Advantages

- Direct/visible fastening solution
- Easy, fast laying of the decking
- Compatible with different Eurotec aluminium system profiles
- Easy replacement of individual decking boards
- Supports constructive timber protection
- Weather-resistant

Visible fastening



Eurotec

Distance strip 2.0

Visible fastening of deck boards

NEW
to our product range

Substructure: Timber

The wooden decking board substructure is individually suitable for visible or invisible attachments of the decking boards. Distance strip 2.0 is very well suited for visible attachments of decking boards. It works as a spacer and allows freedom of movement between panel and substructure. At the same time, it benefits the air circulation. Standard wood screws,

such as Terrassotec screws, are used for the screw connection of a wood substructure.

Distance strip 2.0 reduces the risk of sheared off screws.

Important: Hardwoods/tropical woods should always be pilot-drilled!

Distance strip 2.0

For the secure attachment of decking boards.

Art. no.	Dimensions [mm] ¹⁾	Material	PU*
944803	30 x 700 x 7	Hard plastic	50

¹⁾ Width x length x height

* Screws are not included.
Fastening with Terrassotec screws Ø 4 mm.



Distance strip 2.0 is attached and fixed with Terrassotec screws Ø 4 mm in the holes provided (5 Terrassotec screws are required for one Distance strip 2.0). Distance strip 2.0 is 70 cm long.



Eurotec

Distance strip 2.0 reduces the risk of sheared off screws

Distance strip 2.0 is made of hard plastic and is intended to prevent the stainless steel screws from shearing off. The shearing is caused by the swelling and shrinking of the wood, the so-called working of the wood. This working of the wood is especially pronounced in the transverse direction of the boards. The wood „wants“ to take the screw with it, while the lower part of the screw is still firmly seated in the substructure. Since hard and tropical wood is very hard due to its very high density, the screw does not have a chance of pressing into the wood if the wood is working. If the screw breaks off due to this stress, this is called shearing off. Distance strip 2.0 was developed in order to prevent stainless steel screws from shearing off. It creates a freedom of movement of 7 mm between substructure and decking boards, which gives the stainless steel screws the opportunity to move together with the wood.

What does „shearing off“ mean?

A screw can shear off (tear off) when it does not have enough freedom of movement while the wood is swelling and shrinking. With the help of Distance strip 2.0, a distance of 7 mm is achieved between the board and substructure, which allows the screws to adjust to the movements of the wood. In this way, shearing off is prevented.

Schematic representation »shearing«

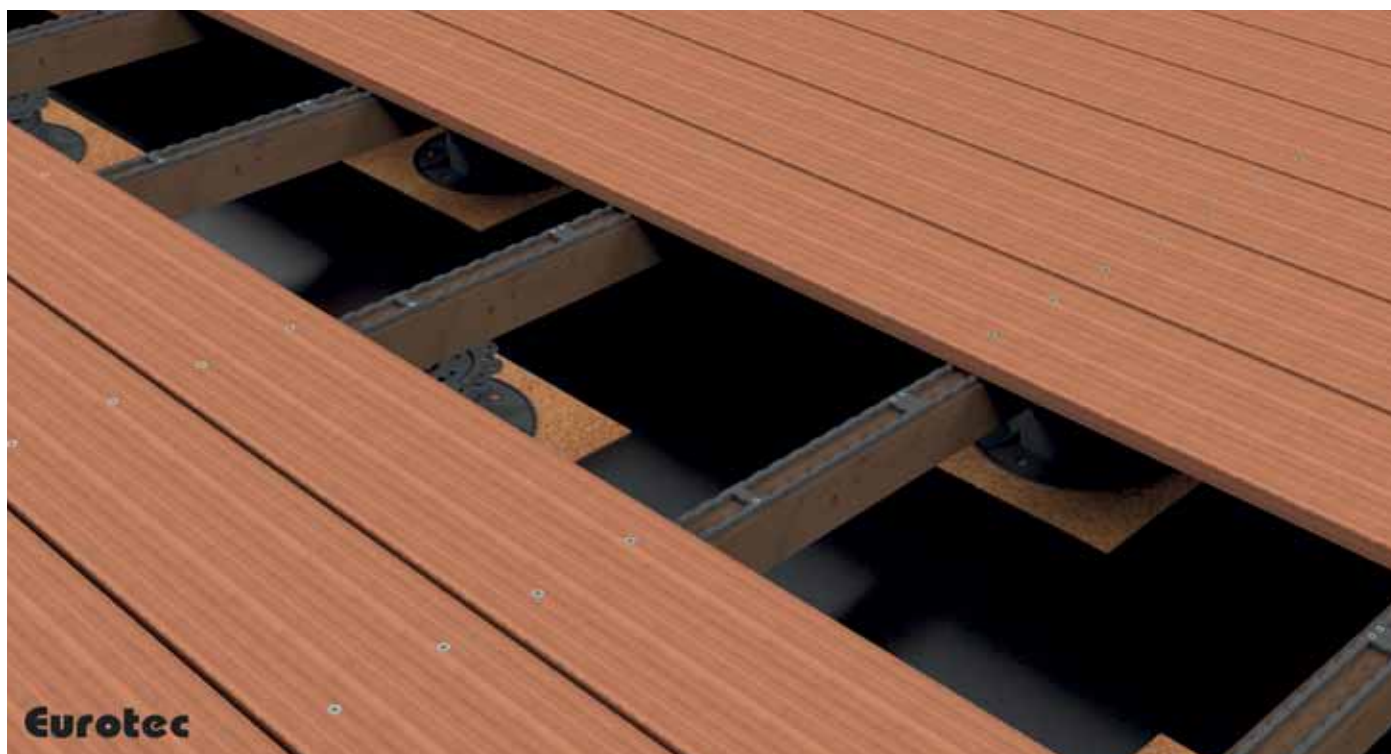
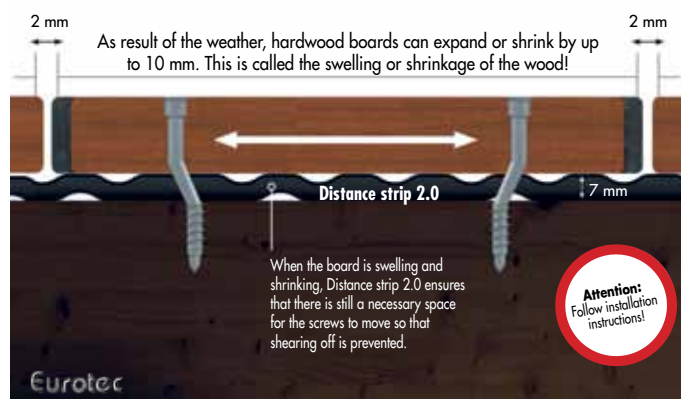
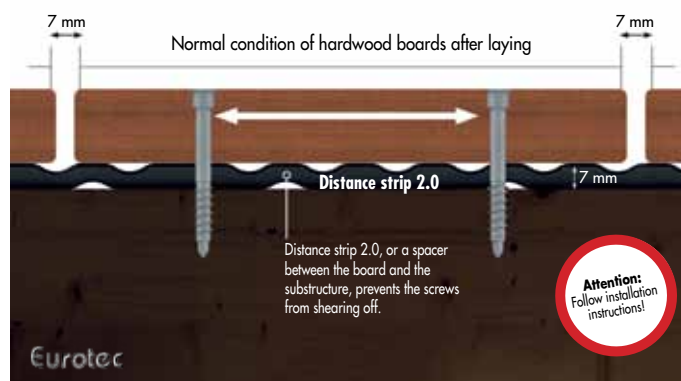

Profile drilling screw / Wing-tipped profile drilling screw



The profile drilling screws are suitable for the visible fixing of decking on the **Eurotec aluminium profiles, aluminium system profile EVO, EVO Light, HKP support profile and aluminium function strip.**



Visible fastening by means of a profile drill screw on an aluminium EVO system profile

Profile drilling screw

Hardened stainless steel

Stainless Steel

New dimension

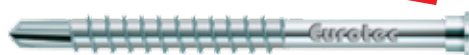

- Limited resistance to acid
- 10 years experience without corrosion problems with suitable woods
- Not suitable for woods containing high amounts of tanning agents, such as cumarú, oak, merbau, robinia, etc.
- Not suitable for use in chlorous atmospheres
- Stainless steel in accordance with DIN 10088

Art. no.	Dimensions [mm]	Drive	Board thickness [mm]	PU
905553	5,5 x 41	TX25 •	16 - 20	200
905559	5,5 x 46	TX25 •	21 - 25	200
905562	5,5 x 51	TX25 •	26 - 30	200
975797	5,5 x 56	TX25 •	30 - 36	200
905560	5,5 x 61	TX25 •	36 - 40	200



Suitable for this:
Drill-Stop for Profile
drilling screw
Art. no.: 945606

Profile drilling screw

Stainless steel A4

Stainless Steel

New dimension



- Limited resistance to acid
- Suitable for use with woods containing tanning agents such as cumarú, oak, merbau, robinia, etc.
- Suitable for saline atmospheres
- Not suitable for use in chlorous atmospheres

Art. no.	Dimensions [mm]	Drive	Board thickness [mm]	PU
905571	5,5 x 41	TX25 •	16 - 20	200
905563	5,5 x 46	TX25 •	21 - 25	200
905564	5,5 x 51	TX25 •	26 - 30	200
975798	5,5 x 56	TX25 •	30 - 36	200
905565	5,5 x 61	TX25 •	36 - 40	200



Suitable for this:
Drill-Stop for Profile
drilling screw
Art. no.: 945606

Note The board should always be pilot-drilled to a diameter of 5,5 mm.

Wing-tipped profile drilling screw

Hardened stainless steel

Stainless Steel



- Limited resistance to acid
- 10 years experience without corrosion problems with suitable woods
- Not suitable for woods containing high amounts of tanning agents, such as cumarú, oak, merbau, robinia, etc.
- Not suitable for use in chlorous atmospheres
- Stainless steel in accordance with DIN 10088

Art. no.	Dimensions [mm]	Drive	Board thickness [mm]	PU
905568	5,0 x 55	TX20 •	20 - 25	200
905569	5,0 x 60	TX20 •	26 - 30	200
905570	5,0 x 70	TX20 •	35 - 40	200

Special feature

- Screws in quickly without pilot drilling

Please refer to the information we provide on "Selecting screw steels" (p. 8), as not all timber types should be installed with hardened stainless-steel screws.

Terrassotec Trilobular / Terrassotec / Tri-Deck-Tec



Which
screw steel for
which timber?
Please refer to p. 8

Advantages of Terrassotec Trilobular

Special screw geometry

- Drive thread ensures quick screwing
- Reinforced shank reduces risk of breaking or shearing off
- Under-head thread provides additional hold for deck boards

Trilobular base geometry

- Reduced installation torque
- Reduced risk of screw breaking during screwing



Two-step head with under-head toothing

- Reduced splintering
- Reduced risk of timber splitting



Reinforced shank

- Suitable for many tropical woods
- Reduced risk of screw shearing off

Advantages of Terrassotec

- Reduced splintering through special head
- With self-milling ribs for sinking easily in all wood types
- The screw geometry reduces the danger of splitting, but pilot drilling is recommended in particular for hardwoods and in deck and façade construction!

Check the information from the board manufacturer.

Terrassotec Trilobular

Terrassotec Trilobular

Hardened stainless steel



Stainless Steel



- Limited resistance to acid
- 10 years experience without corrosion problems with suitable woods
- Not suitable for woods containing high amounts of tanning agents, such as cumaru, oak, merbau, robinia, etc.
- Not suitable for use in chlorous atmospheres
- Stainless steel in accordance with DIN 10088

Art. no.	Dimensions [mm]	Drive	PU
905530	5,5 x 50	TX25 •	200
905529	5,5 x 60	TX25 •	200
905531	5,5 x 70	TX25 •	200
905538	5,5 x 80	TX25 •	200
905545	5,5 x 90	TX25 •	200
905546	5,5 x 100	TX25 •	200
905530-EIMER	5,5 x 50	TX25 •	500
905529-EIMER	5,5 x 60	TX25 •	500
905531-EIMER	5,5 x 70	TX25 •	500
905538-EIMER	5,5 x 80	TX25 •	500
905545-EIMER	5,5 x 90	TX25 •	500
905546-EIMER	5,5 x 100	TX25 •	500

Terrassotec Trilobular

Stainless steel A2



Stainless Steel



- Limited resistance to acid, relatively soft
- Not suitable for use in chlorous atmospheres

Art. no.	Dimensions [mm]	Drive	PU
905539	5,5 x 50	TX25 •	200
905540	5,5 x 60	TX25 •	200
905541	5,5 x 70	TX25 •	200
905542	5,5 x 80	TX25 •	200
905539-EIMER	5,5 x 50	TX25 •	500
905540-EIMER	5,5 x 60	TX25 •	500
905541-EIMER	5,5 x 70	TX25 •	500
905542-EIMER	5,5 x 80	TX25 •	500

Terrassotec Trilobular

Stainless steel A4



Stainless Steel



- Limited resistance to acid
- Suitable for use with woods containing tanning agents such as cumarú, oak, merbau, robinia, etc.
- Suitable for saline atmospheres
- Not suitable for use in chlorous atmospheres

Art. no.	Dimensions [mm]	Drive	PU
905555	5,5 x 50	TX25 •	100
905556	5,5 x 60	TX25 •	100
905557	5,5 x 70	TX25 •	100
905558	5,5 x 80	TX25 •	100
905547*	5,5 x 90	TX25 •	100
905548*	5,5 x 100	TX25 •	100
905555-EIMER	5,5 x 50	TX25 •	500
905556-EIMER	5,5 x 60	TX25 •	500
905557-EIMER	5,5 x 70	TX25 •	500
905558-EIMER	5,5 x 80	TX25 •	500

* The previous version will continue to be supplied until the switchover is complete.

Terrassotec Trilobular

Hardened stainless steel, antique



Stainless Steel



- Limited resistance to acid
- 10 years experience without corrosion problems with suitable woods
- Not suitable for woods containing high amounts of tanning agents, such as cumarú, oak, merbau, robinia, etc.
- Not suitable for use in chlorous atmospheres
- Stainless steel in accordance with DIN 10088

Art. no.	Dimensions [mm]	Drive	PU
B905530	5,5 x 50	TX25 •	200
B905529*	5,5 x 60	TX25 •	200
B905531	5,5 x 70	TX25 •	200

* The previous version will continue to be supplied until the switchover is complete.

Terrassotec

Terrassotec

Stainless steel A4, antique



Stainless Steel

- Limited resistance to acid
- Suitable for use with woods containing tanning agents such as cumarú, oak, merbau, robinia, etc.
- Suitable for saline atmospheres
- Not suitable for use in chlorous atmospheres



Terrassotec

Hardened stainless steel



Can be combined with EPDM façade tape

Stainless Steel

- Limited resistance to acid
- 10 years experience without corrosion problems with suitable woods
- Not suitable for woods containing high amounts of tanning agents, such as cumarú, oak, merbau, robinia, etc.
- Not suitable for use in chlorous atmospheres
- Stainless steel in accordance with DIN 10088
- 50% greater breaking torque than A2 and A4
- Magnetizable



Art. no.	Dimensions [mm]	Drive	PU
B905558*	5,5 x 90	TX25 ●	100
B905559*	5,5 x 100	TX25 ●	100

* Discontinued item

Art. no.	Dimensions [mm]	Drive	PU
905535	4,0 x 40	TX15 ●	500
905536	4,0 x 50	TX15 ●	500
905537	4,0 x 60	TX15 ●	500
945811	4,5 x 40	TX20 ●	200
905528	4,5 x 45	TX20 ●	200
905520	4,5 x 50	TX20 ●	200
905521	4,5 x 60	TX20 ●	200
905522	4,5 x 70	TX20 ●	200
905527	5,0 x 45	TX25 ●	200
905523	5,0 x 50	TX25 ●	200
905524	5,0 x 60	TX25 ●	200
905525	5,0 x 70	TX25 ●	200
905526	5,0 x 80	TX25 ●	200
905544	5,0 x 90	TX25 ●	200
905543	5,0 x 100	TX25 ●	200
905520-EIMER	4,5 x 50	TX20 ●	500
905523-EIMER	5,0 x 50	TX25 ●	500
905524-EIMER	5,0 x 60	TX25 ●	500
905525-EIMER	5,0 x 70	TX25 ●	500
905526-EIMER	5,0 x 80	TX25 ●	500

PRACTICAL: Here's everything you need!

Terrassotec screws

Sales unit in bucket with 500 pieces



Stainless Steel

incl. Drill-Stop



incl. TX 25 Bit



Tri-Deck-Tec

With coloured screw heads for WPC decking
On request

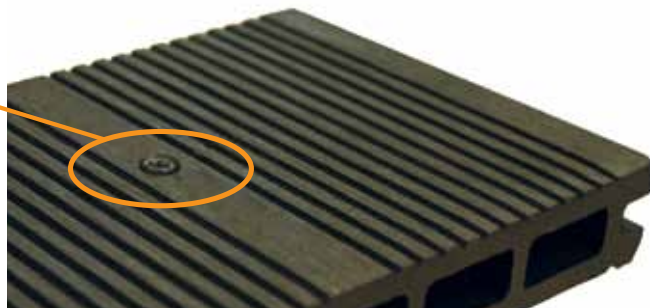

Tri-Deck-Tec

Hardened stainless steel

Stainless Steel



Art. no.	Dimensions [mm]	Colour	Drive	PU
905809	5,0 x 65	Blank	TX20	200
BR905809-EIMER	5,0 x 65	Brown / NCS S 7010-Y50R	TX20	250*
C905809-EIMER	5,0 x 65	Charcoal / NCS 8000-N matt	TX20	250*
CR905809-EIMER	5,0 x 65	Cream / NCS 3010-Y30R matt	TX20	250*
GR905809-EIMER	5,0 x 65	Grey / NCS S5500-N matt	TX20	250*
OAK905809-EIMER	5,0 x 65	Oak / NCS S2050-Y30R matt	TX20	250*
RW905809-EIMER	5,0 x 65	Redwood / NCS S030-Y50R matt	TX20	250*

* Supplied in a bucket incl. ECO drill stop and bit TX20.

Advantages

- Reduced risk of timber splitting
- Drive thread ensures quick screwing
- Under-head thread provides additional hold for deck boards
- Reduced splintering through special head
- Reduction of screw torque due to trilobular basic geometry
- Reduction of the risk of tearing off the screw when screwing through trilobular basic geometry

EXPERT HINTS for the construction of wooden terraces

Wood deck = pilot-drilling

When building a wood deck using premium woods pilot-drilling and pre-counterboring is recommended in all circumstances. This applies to soft coniferous wood as well as to hardwood.

Drill-Stop for:

- Terrassotec Ø 5 und 5,5 mm
- Tri-Deck-Tec Ø 5 mm
- Hapatec Ø 5 mm
- Hapatec Heli Ø 5 mm

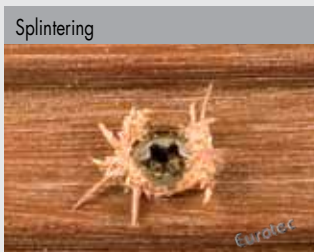

No splintering, no shearing!

By pre-drilling with the Drill-Stop and the especially developed head-shape of the Terrassotec and Tri-Deck-Tec screws, the risk of splintering is greatly reduced.

Eurotec Basic Shop

Everything at a glance



The Basic Shop is the cost-effective and space-saving alternative for selling the Eurotec Terrassotec trilobular with painted screw heads.

The shelf has the following dimensions:

Height 1750 mm, width 338 mm, depth 500 mm

Hapatec screws

Hapatec

Panel fastener hardwood, stainless steel, hardened



- Limited resistance to acid
- 10 years experience without corrosion problems with suitable woods
- Not suitable for woods containing high amounts of tanning agents, such as cumarú, oak, merbau, robinia, etc.
- Not suitable for use in chlorous atmospheres
- Stainless steel in accordance with DIN 10088
- 50% greater breaking torque than A2 and A4
- Magnetizable

Art. no.	Dimensions [mm]	Drive	PU
111803	4,0 x 30	TX15 ●	500
111810	4,0 x 40	TX15 ●	500
111821	4,0 x 45	TX15 ●	500
111811	4,0 x 50	TX15 ●	500
111812	4,0 x 60	TX15 ●	500
904569	4,5 x 45	TX20 ●	200
111813	4,5 x 50	TX20 ●	200
111814	4,5 x 60	TX20 ●	200
111815	4,5 x 70	TX20 ●	200
111816	4,5 x 80	TX20 ●	200
100048	5,0 x 40	TX25 ●	200
100049	5,0 x 45	TX25 ●	200
111817	5,0 x 50	TX25 ●	200
111818	5,0 x 60	TX25 ●	200
111819	5,0 x 70	TX25 ●	200
111820	5,0 x 80	TX25 ●	200
111888	5,0 x 90	TX25 ●	200
111889	5,0 x 100	TX25 ●	200
904569-EIMER	4,5 x 45	TX20 ●	500
111813-EIMER	4,5 x 50	TX20 ●	500
111814-EIMER	4,5 x 60	TX20 ●	500
111815-EIMER	4,5 x 70	TX20 ●	500
111816-EIMER	4,5 x 80	TX20 ●	500
100048-EIMER	5,0 x 40	TX25 ●	500
111817-EIMER	5,0 x 50	TX25 ●	500
111818-EIMER	5,0 x 60	TX25 ●	500
111819-EIMER	5,0 x 70	TX25 ●	500
111820-EIMER	5,0 x 80	TX25 ●	500

Hapatec »antique«

Panel fastener hardwood, stainless steel, hardened



- Limited resistance to acid
- 10 years experience without corrosion problems with suitable woods
- Not suitable for woods containing high amounts of tanning agents, such as cumarú, oak, merbau, robinia, etc.
- Not suitable for use in chlorous atmospheres
- Stainless steel in accordance with DIN 10088
- 50% greater breaking torque than A2 and A4
- Magnetizable

Art. no.	Dimensions [mm]	Drive	PU
B111817	5,0 x 50	TX25 ●	200
B111818	5,0 x 60	TX25 ●	200

Hapatec black

Panel fastener hardwood, stainless steel, hardened, black

Stainless Steel

NEW
to our product range



- For fixing black façade boards



Art. no.	Dimensions [mm]	Drive	PU
111802/BLACK	4,0 x 35	TX15 ●	500
111810/BLACK	4,0 x 40	TX15 ●	500
111811/BLACK	4,0 x 50	TX15 ●	500
111812/BLACK	4,0 x 60	TX15 ●	500
111822/BLACK	4,5 x 40	TX20 ●	200
111813/BLACK	4,5 x 50	TX20 ●	200
111814/BLACK	4,5 x 60	TX20 ●	200
111815/BLACK	4,5 x 70	TX20 ●	200
111817/BLACK	5,0 x 50	TX25 ●	200
111818/BLACK	5,0 x 60	TX25 ●	200

Hapatec Heli

Stainless steel A4

Stainless Steel

Can be combined with
EPDM
façade tape



- Limited resistance to acid
- Suitable for use with woods containing tanning agents such as cumarú, oak, merbau, robinia, etc.
- Suitable for saline atmospheres
- Not suitable for use in chlorous atmospheres

The special screw geometry reduces the screwing torque. This reduces the danger of the shearing of the relatively soft A4 stainless steel screw.

Art. no.	Dimensions [mm]	Drive	PU
100059	4,5 x 50	TX20 ●	200
100055	4,5 x 60	TX20 ●	200
100056	4,5 x 70	TX20 ●	200
100057	4,5 x 80	TX20 ●	200
100051	5,0 x 50	TX25 ●	200
100052	5,0 x 60	TX25 ●	200
100053	5,0 x 70	TX25 ●	200
100054	5,0 x 80	TX25 ●	200
100058	5,0 x 100	TX25 ●	200
100051-EIMER	5,0 x 50	TX25 ●	500
100052-EIMER	5,0 x 60	TX25 ●	500
100053-EIMER	5,0 x 70	TX25 ●	500
100054-EIMER	5,0 x 80	TX25 ●	500

Hapatec Heli

Stainless steel A2

Stainless Steel

Can be combined with
EPDM
façade tape



A2 stainless steel

- Limited resistance to acid
- Not suitable for atmospheres containing chlorine

Art. no.	Dimensions [mm]	Drive	PU
100060	5,0 x 50	TX25 ●	200
100062	5,0 x 60	TX25 ●	200
100060-EIMER	5,0 x 50	TX25 ●	500
100062-EIMER	5,0 x 60	TX25 ●	500

Hobotec screws

Hobotec screws enable simple, fast and clean connections of wood to wood. These screws are used in particular in applications where there is an increased danger of cracking and splitting. The type of thread and the innovative drill point enable a clean fit and high extraction resistance values.

Specially suitable for applications in model construction, stairs construction, façade construction for carpentry work, joinery and roofing.

Application range for screws made of hardened stainless steel:

- This steel combines the best properties of carbon and stainless steels. Conditionally rust-resistant like an A2 with the high mechanical values of a galvanised steel. Hardened stainless steel is not acid-resistant, which is why it is also not suitable for fastening wood containing tanning agents (e.g. oak).
- Hardened stainless steel can be magnetised.
- Stainless steel in accordance with DIN 10088.

For further information on possibilities for using hardened stainless steel see p. 8



© fotolia.de

Hobotec screw

Hardened stainless steel

Can be
combined with
EPDM
façade tape

Stainless Steel



Advantages

- No pilot drilling required
- No cracking or splitting in narrow edge areas
- No hammering of the screws through TX drive

Art. no.	Dimensions [mm]	Drive	PU
903323	4,0 x 30	TX15 ●	500
110299	4,0 x 40	TX15 ●	500
110300	4,0 x 45	TX15 ●	500
110301	4,0 x 50	TX15 ●	500
110302	4,0 x 60	TX15 ●	500
110319	4,5 x 40	TX20 ●	200
944839	4,5 x 45	TX20 ●	200
110303	4,5 x 50	TX20 ●	200
110304	4,5 x 60	TX20 ●	200
110305	4,5 x 70	TX20 ●	200
110306	4,5 x 80	TX20 ●	200
110307	5,0 x 50	TX25 ●	200
110308	5,0 x 60	TX25 ●	200
110309	5,0 x 70	TX25 ●	200
110310	5,0 x 80	TX25 ●	200
110311	5,0 x 90	TX25 ●	200
110312	5,0 x 100	TX25 ●	200
110313	6,0 x 80	TX25 ●	100
110314	6,0 x 90	TX25 ●	100
110315	6,0 x 100	TX25 ●	100
110316	6,0 x 120	TX25 ●	100
110317	6,0 x 140	TX25 ●	100
110318	6,0 x 160	TX25 ●	100



© fotolia.de

Hobotec ornamental head

Hardened stainless steel

Can be combined with
EPDM
façade tape

Stainless Steel



Application

- Façades
- Fences
- Decks



Art. no.	Dimensions [mm]	Drive	PU
945040	4,0 x 40	TX15 ●	500
945653	4,0 x 45	TX15 ●	500
945041	4,0 x 50	TX15 ●	500
945042	4,0 x 60	TX15 ●	500
945043	4,0 x 70	TX15 ●	500
945045	4,5 x 40	TX20 ●	200
945046	4,5 x 45	TX20 ●	200
945047	4,5 x 50	TX20 ●	200
945048	4,5 x 60	TX20 ●	200
945049	4,5 x 70	TX20 ●	200
945050	4,5 x 80	TX20 ●	200
945051	5,0 x 50/30	TX25 ●	200
945052	5,0 x 60/36	TX25 ●	200
945053	5,0 x 70/42	TX25 ●	200
945054	5,0 x 80/48	TX25 ●	200
945055	5,0 x 90/54	TX25 ●	200
945056	5,0 x 100/60	TX25 ●	200

The type of thread and the innovative drill point enable a clean fit and high extraction resistance values. **Particularly suitable** for brittle woods. **Not suitable** for tannin-rich woods such as cumarú, oak, merbau, robinia, etc.

These screws are used in particular in applications where there is a high risk of splitting.

E.g. when laying wood floors, wood mouldings, etc.



Hobotec ornamental head

Steel blue galvanised



Art. no.	Dimensions [mm]	Drive	PU
110287	3,2 x 20	TX10 ◯	500
110288	3,2 x 25	TX10 ◯	500
110289	3,2 x 30	TX10 ◯	500
110290	3,2 x 35	TX10 ◯	500
110291	3,2 x 40	TX10 ◯	500
110292	3,2 x 50	TX10 ◯	500
110293	3,2 x 60	TX10 ◯	500

Also available with head painted white

w110288	3,2 x 25	TX10 ◯	500
w110289	3,2 x 30	TX10 ◯	500
w110290	3,2 x 35	TX10 ◯	500
w110291	3,2 x 40	TX10 ◯	500
w110292	3,2 x 50	TX10 ◯	500
w110293	3,2 x 60	TX10 ◯	500

Hobotec ornamental head

Hardened stainless steel



Stainless Steel



Art. no.	Dimensions [mm]	Drive	PU
900782	3,2 x 25	TX10 ◯	500
110294	3,2 x 30	TX10 ◯	500
110295	3,2 x 35	TX10 ◯	500
110296	3,2 x 40	TX10 ◯	500
110297	3,2 x 50	TX10 ◯	500
110298	3,2 x 60	TX10 ◯	500

Hobotec ornamental head

Brass-plated



Art. no.	Dimensions [mm]	Drive	PU
903436	3,2 x 25	TX10 ◯	500
903437	3,2 x 30	TX10 ◯	500
903438	3,2 x 35	TX10 ◯	500
903439	3,2 x 40	TX10 ◯	500
903440	3,2 x 50	TX10 ◯	500
903441	3,2 x 60	TX10 ◯	500

Hobotec ornamental head

Steel yellow galvanised



Art. no.	Dimensions [mm]	Drive	PU
110280	3,2 x 20	TX10 ◯	500
110281	3,2 x 25	TX10 ◯	500
110282	3,2 x 30	TX10 ◯	500
110283	3,2 x 35	TX10 ◯	500
110284	3,2 x 40	TX10 ◯	500
110285	3,2 x 50	TX10 ◯	500
110286	3,2 x 60	TX10 ◯	500
944778	4,2 x 70	TX15 ●	200
944779	4,2 x 80	TX15 ●	200

Mammutec screw

Suitable for stronger wood surfaces

Mammutec screw

The Mammutec is specially designed for the attachment of stronger wooden flooring with a thickness of up to a maximum of 60 mm. The Mammutec screw can also be used in jetties and piers due to its high corrosion resistance.



Mammutec

Stainless steel A4

Stainless Steel

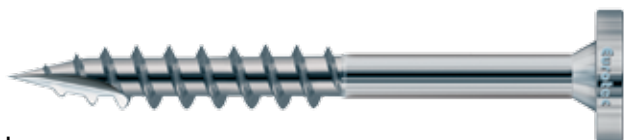

Advantages

- Corrosion resistance
- Fixing of wood coverings with a thickness of up to 60 mm

Application information

Pre-drilling and countersinking of 6 mm is absolutely necessary! This gives you space for the shaft. Due to the material thickness, there is always the risk of screw shearing due to shrinkage and swelling of the timber.

This must be observed during assembly.

Art. no.	Dimensions [mm]	Drive	PU
905575	8,0 x 100	TX40 •	50
905576	8,0 x 120	TX40 •	50



Aids for laying decking boards



Bit dispenser box

A practical dispenser box with **100 x TX Long Bits** or **50 x Magnet TX Long Bits** in the sizes: TX20, TX25, TX30 or TX40.

The **magnet bits** provide an extremely strong hold and therefore prevent screws from falling. Even long screws remain securely held in place, even in a horizontal position.

The **TX Long Bit** is ideal for use in hard-to-reach places, e.g. deck boards, cladding, etc.

Bit dispenser box with TX Long Bits

Black

Art. no.	Size	Bit	PU
954102	TX20		100
954103	TX25		100
954104	TX30		100
954105	TX40		100

Bit dispenser box with Magnet TX Long Bits

Black

Art. no.	Size	Bit	PU
954106	TX20		50
954107	TX25		50
954108	TX30		50
954109	TX40		50

Bit holder



Art. no.	Length [mm]	PU
500011	66	1
500012	150	1
500013	500	1

Bit-Box

Specially made for wood construction



Description

31 TX bits and 1 quick-change bit holder in a practical box with a belt clip.



Available to order individually or as a 10-pack incl. Sales display.

Art. no.	Content	PU
945857	5 x TX10 ○	1
	5 x TX15 ●	
	5 x TX20 ●	
	5 x TX25 ●	
	5 x TX30 ●	
	6 x TX40 ●	
	1 x quick-change bit holder	

Universal Bit-Box

For universal applications



Description

48 bits and 1 quick-change bit holder in a practical box.

Art. no.	Description	PU
945858	⊕ PH 1-1-2-2-3-3	1
	⊕ PZ 1-1-2-2-3-3	
	○ Hex 4-4-5-5-6-6	
	□ Square 1-1-2-2-3-3	
	⊗ TX 10-10-15-15-20-20-25-25-27-27-30-30	
	⊗ SI-TX 10-10-15-15-20-20-25-25-27-27-30-30	
	1 x quick-change bit holder	

Angled screwing attachment

For hard-to-reach locations



Art. no.	Description	PU
499999	Angled screwing attachment	1

- Head angled at 90°
- Compatible with all standard bits and machines
 - Magnetic 1/4" hexagonal bit holder
 - 1/4" hexagonal machine inputs
- Handle can be rotated and locked in 30° steps
- Suitable for clockwise and anti-clockwise rotation
- Maximum torque: 62 Nm
- Maximum speed of rotation: 2000 U/min
- Comes supplied with 1 bit each for TX20, TX25 and TX30

Stainless steel Long Bit

1/4" x 50 mm



Art. no.	Size	Bit	PU
500055	TX10 ◯		20
500056	TX15 ●		20
500057	TX20 ●		20
500058	TX25 ●		20
500059	TX30 ●		20

Advantages

- Protection against the risk of flash rust
- Avoidance of follow-up costs due to flash rust

Magnet TX Long Bit

1/4" x 50 mm



Art. no.	Size	Bit	PU
499993	TX10 ◯		5
499994	TX15 ●		5
499995	TX20 ●		5
499996	TX25 ●		5
499997	TX30 ●		5
499998	TX40 ●		5

Content

- 5 Magnet TX Long Bits in a practical blister pack with standard European perforation

Advantages

- Extremely strong hold in every position
- No falling screws

Description

The magnet bits from Eurotec provide an extremely strong hold and therefore prevent screws from falling. Even long screws remain securely in place, and even in a horizontal position.

Magnet Bit Set



6 sizes in a blister pack.

Art. no.	Size	PU
499992	TX10 / TX15 / TX20 / TX25 / TX30 / TX40	6



12in1 ratchet screwdriver



Art. no.	Dimensions [mm] ^{a)}	Weight [g]	PU
800490	250 x 35	265	1

^{a)} Length x Width

Advantages

- Ratchet function - saves having to regripping
- 12 bits in the extendible clip
- Ergonomic and non-slip handle



Eurotec

TX Bit

1/4" x 25 mm



Art. no.	Size	Bit	PU
945851	TX10 ○		10
945852	TX15 ●		10
945853	TX20 ●		10
945854	TX25 ●		10
945855	TX30 ●		10
945856	TX40 ●		10

TX Long Bit

1/4" x 50 mm



Art. no.	Size	Bit	PU
Länge: 50 mm			20
954666	TX10 ○		20
945975	TX15 ●		20
945976	TX20 ●		20
945977	TX25 ●		20
945978	TX30 ●		20
945979	TX40 ●		20
954658	TX50 ●		10

Advantage

A firm hold in any position!

Description

The long bit is suitable for use in hard-to-reach places, such as terrace boards, cladding and so on. It is suitable for use with common electric / battery-powered screwdrivers and can thus be used directly or with an adapter.

- The long bit can be used for relatively inaccessible connections such as two wooden boards. Fixing is an absolute doddle, and no damage is caused to the boards by a drill chuck.



Tip
Simply connect 6 long bit packages (each containing 20 bits of one size) ... and you'll have a handy storage box.

Quick-change bit holder

For each 1/4" x 25 mm bit



Art. no.	Description	PU*
945850	Quick-change bit holder 1/4" x 25 mm Bit	1

* Bit supplied separately

Description

Eurotec's bit holder is an ideal auxiliary tool for any craftsman. Once the bit is inserted into the bit holder, it no longer falls out by itself.

Spacers

With this spacer, 4 different joint dimensions can be set when laying the boards (4, 5, 6 and 8 mm).

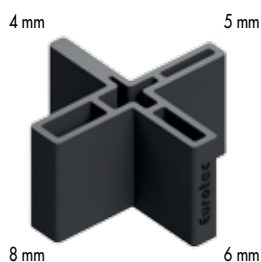

Art. no.	Dimensions [mm]	Material	PU
945381	42 x 22	Plastic, black	25

Tenax spacer

If deck boards are to be screwed directly, ie visibly, the Tenax serves as a spacer to the underlay to prevent waterlogging in the joint. By placing the boards on top, the joint gap of 6 mm and the clearance to the substructure are set.

- Optimum back ventilation
- Optimum clearance



Art. no.	Dimensions [mm]	Material	PU
945968	11 x 30 x 86	Plastic, black	300



Tension clamp

Incl. detachable plastic jaws



The tension clamp is an essential aid for laying deck boards. Use at least 4 tension clamps to bring the boards into shape along their whole length. Along with the spacers, for example, this achieves an even joint pattern with straight deck boards.

Art. no.	Dimensions [mm]	Material	PU
945380	270 x 830 x 55	Hard plastic/steel	1



Drill-Stop

Countersinking for deck screws



For Terrasotec Ø 5 mm and
Hapatec Ø 5 mm and
Hapatec Heli Ø 5 mm

Pilot drilling is strongly recommended for fastening tropical woods/hardwoods. This is advisable even with the relatively easily splittable Douglas fir, and when screwing close to wood cut against the grain.

- Boring and countersinking in a single pass
- Screwing torque for inserting Terrasotec and Hapatec screws is greatly reduced, i.e. no more shearing of the screws, above all with the combination of hardwood/stainless steel A2 or A4.
- Perfect seat of the screw head

Art. no.	Dimensions [mm] ^{a)}	Material	Stopper collar	PU
945986	Ø 4,7 x 25	Hard plastic/steel	orange	1

a) Drilling diameter x drilling depth

Drill-Stop for Profile drilling screw

Countersinking for Profile drilling screw

NEW
to our product range



Pilot drilling is strongly recommended for fastening tropical woods/hardwoods. This is advisable both for Douglas fir, which is relatively easy to split, and when screwing close to wood cut against the end grain.

- Boring and countersinking in a single pass
- The screwing-in torque for inserting profile drilling screws is greatly reduced, i.e. no more screw shearing, particularly when combining hardwood and A2 or A4 stainless steel
- Perfect seat of the screw head
- Optimised for the Eurotec 5,5 mm profile drilling screw

Art. no.	Dimensions [mm] ^{a)}	Material	Stopper collar	PU
945606	Ø 5,6 x 26	Hard plastic/steel	blue	1

a) Drilling diameter x drilling depth

Screw Stop

Screw coupling with depth stopper



The Screw Stop is the ideal solution for driving screws to an even depth into the wood. In this way, your deck will be given an attractive, even surface pattern. You adjust the required screwing depth with the infinitely adjustable depth stopper. When this is reached, the drive uncouples and the screw stops. You do not have to start again to adjust the seat of the screw head.

Art. no.	Dimensions [mm]	Material	PU*
500000	61,5 - 70 ; Ø 24	Hard plastic/steel	1

* Incl. TX25 Bit. The bit is locked in place by a lock washer and can be changed by using a pincer.



Façadeclip

For hidden fastening of façade wood

Façadeclip

Black, electrogalvanised

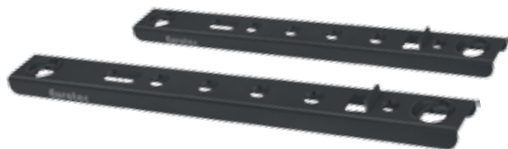

Advantages

- For façade timbers with a profile height of 57–95 mm
- Hidden fastening
- Perfect constructive timber protection
- Ventilated façade system with spaced installation
- The façade timber's surface that is exposed to the weather remains undamaged
- Efficient and easy installation



Technical data

Art. no.	Dimensions [mm] ^{a)}	Type	PU*
946010	5,5 x 115 x 15	F115 x 17	300
946012	5,5 x 115 x 15	F115 x 22	300
946013	5,5 x 115 x 15	F115 x 28	300
946014	5,5 x 130 x 15	F130 x 17	300
946015	5,5 x 130 x 15	F130 x 22	300
946016	5,5 x 130 x 15	F130 x 28	300
946017	5,5 x 145 x 15	F145 x 17	300
946018	5,5 x 145 x 15	F145 x 22	300
946019	5,5 x 145 x 15	F145 x 28	300

a) Height x length x width

* Screws are included with this product

Eurotec Façadeclip			Dimensions façade profile			Joint clearance between façade profiles		Quantity required Façade clips per m ² Example			
Art. no.	Type	Dimensions [mm]			min.-max. height	min. strength	Assembly screw Length (L)	Fixing screw in hole A	Fixing screw in hole B	min. profile height	max. profile height
		H	W	L	[mm]	[mm]	[mm]	[mm]	[mm]	Stück	Stück
946010	F115 x 17	5,5	115	15	57 - 68	19	17	10	variable	28	24
946012	F115 x 22	5,5	115	15	57 - 68	24	22	10	variable	28	24
946013	F115 x 28	5,5	115	15	57 - 68	30	28	10	variable	28	24
946014	F130 x 17	5,5	130	15	68 - 80	19	17	10	variable	24	20
946015	F130 x 22	5,5	130	15	68 - 80	24	22	10	variable	24	20
946016	F130 x 28	5,5	130	15	68 - 80	30	28	10	variable	24	20
946017	F145 x 17	5,5	145	15	80 - 95	19	17	10	variable	20	18
946018	F145 x 22	5,5	145	15	80 - 95	24	22	10	variable	20	18
946019	F145 x 28	5,5	145	15	80 - 95	30	28	10	variable	20	18

Fastened to substructure with 4,5 x 29 mm fixing screw with drill point

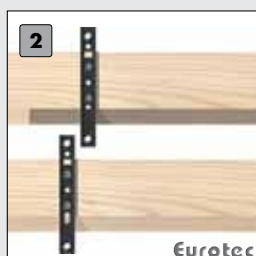
Formula for determining quantity (1000 mm/substructure distance) x (1000 mm/bottom edge clearance) = pieces/m²600 mm substructure clearance
10 mm joint clearancePlease note: Before any work is carried out, all calculations must be checked and released by the responsible planner! For more information on this visit our homepage: www.eurotec.team/en

Efficient and easy installation

- 1 Place Façadeclip on the back with stopper and insert assembly screws
- 2 Repeat on all façade boards displaced
- 3 FScrew the façade wood to the counter-lathe with fixing screw
- 4 Simply insert the next façade wood and screw on the top only with fixing screw
- 5 The joint clearance is set automatically by the screw head of the fixing screw, that's it!

Each Façadeclip comes supplied with one 4,5 x 29 mm fixing screw with a drill point and two 4,2 x L assembly screws.

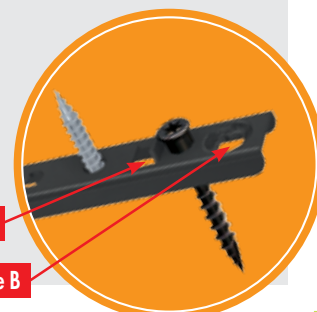

Façadeclip for Rhombus profiles

For use with the most common façade profiles

Façadeclip for Rhombus profiles

System consisting of a Façadeclip Rhombus Starter and a Façadeclip Rhombus

Façadeclip Rhombus



Façadeclip Rhombus Starter

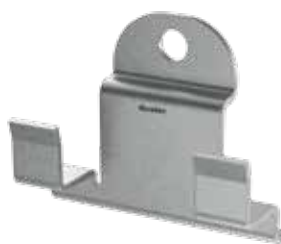

Advantages

- Optimised rear ventilation by constructive timber protection - Exclusive to Eurotec!
- Invisible fastening
- Formation of fixed points and sliding points
- Easy installation
- Weather-resistant

Properties

Using the clip creates a joint dimension of 6 mm. The clip was designed so that it does not rest flat on the substructure, instead it elevates the boards by 4mm from the substructure. The constructional wood protection allows for rear ventilation of the façade, which is not the case with any of the usual products. Rear ventilation results in better drying when the façade is exposed to rain, and water can run off between the clip and substructure. The constructional measures increase the façade's service life.

Properties Rhombus Profiles

- Dimensional stability must be provided for wood
- Low to moderate gross density
- Low swelling and shrinkage
- Suitable for wood that is low in tannin

Coniferous woods*



Thermally modified timber*



* Other wood can also be used, but please ask your wood supplier.

Art. no.	Description	Dimensions [mm] ^{a)}	Material	PU*
944917-50	Façadeclip Rhombus	15,20 x 54,5 x 29,5	Galvanised steel	50
944917-200	Façadeclip Rhombus	15,20 x 54,5 x 29,5	Galvanised steel	200
944918	Façadeclip Rhombus Starter	15,25 x 29,5 x 36,0	Galvanised steel	25

a) Height x length x width

* Incl. screws

Technical data:

Façadeclip Rhombus

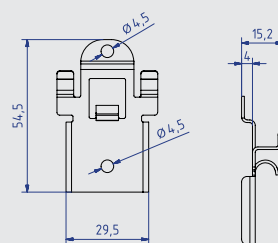

Façadeclip Rhombus Starter

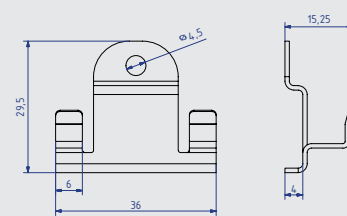

Eurotec

Profile

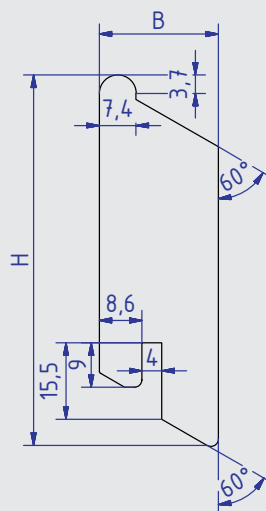

Wall-connection



Detail A



Eurotec

In the case of vertical installation, the following points must be observed when using the Façadeclip Rhombus Starter. We recommend making a 15° undercut for forming a drip edge in the rhombus profile. The Façadeclip Rhombus Starter fits perfectly with a 4 mm wide groove slit in the wood profile (see detail A).

Dimensions		
Variants	Height H [mm]	Width W [mm]
Variants 1	70	21
Variants 2	75	24

Installation instructions: Horizontal fixing

- 1** The Façadeclip Rhombus Starter must be attached to the lower end of the façade. Can be fixed and aligned with the enclosed screw. This is done over the entire length of the façade.

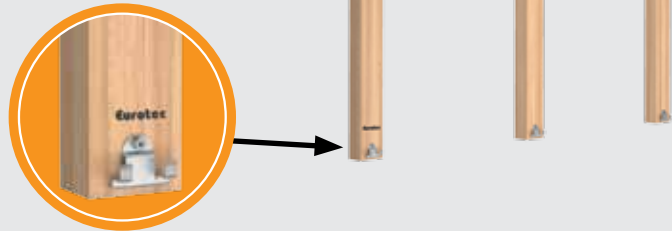

- 2** The first board can be placed on the pre-fixed Façadeclips Rhombus Starter. Through the fixation to the substructure, the profile is securely on to the pre-assembled clips.

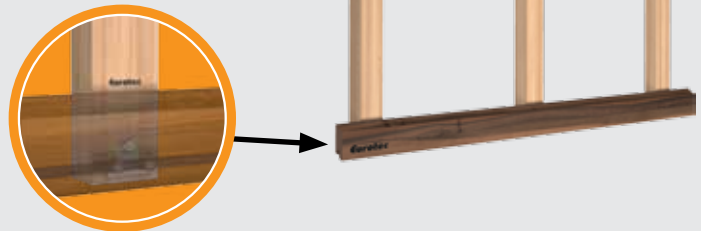

- 3** It is recommended to install the first Façadeclip Rhombus in the middle of the first profile. This will give the first profile a better hold.

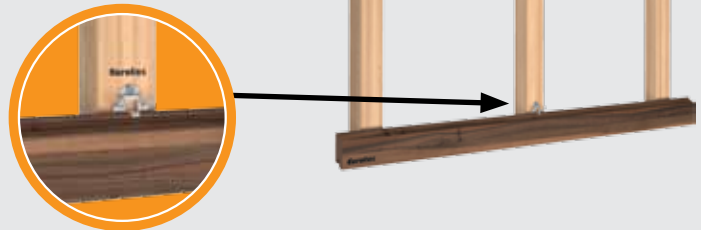

- 4** The remaining Façadeclips Rhombus can be mounted along the profile. For this purpose they are pushed between the plank and the substructure and fixed with the enclosed screw. The screws of all clips must be sufficiently tightened.

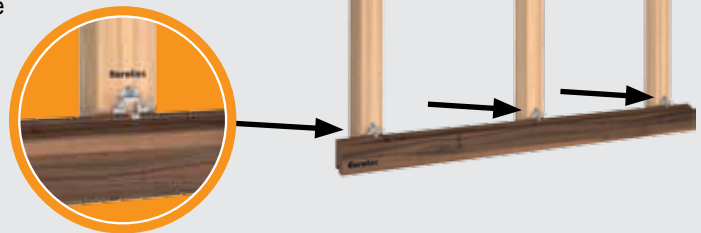

- 5** In this step the next plank is inserted. From here, steps **3 and 4** are repeated until the façade is completely closed.

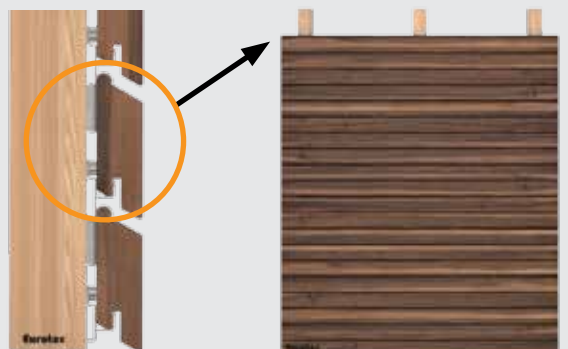

For areas where windows, doors, floorboard joints or the end of the façade is/are located, fixed points can be formed thanks to the prefabricated hole in the Façadeclips Rhombus. To achieve this, the clip is firstly screwed down on the rear of the profile. The clip can then be screwed to the substructure.

Installation instructions: Vertical fixing

- 1** The Façadeclip Rhombus Starter must be fixed and aligned at the first substructure joist of the façade with the enclosed screw. This is done over the entire length of the façade. The specified dimensions of the profile to be installed must be taken into account.

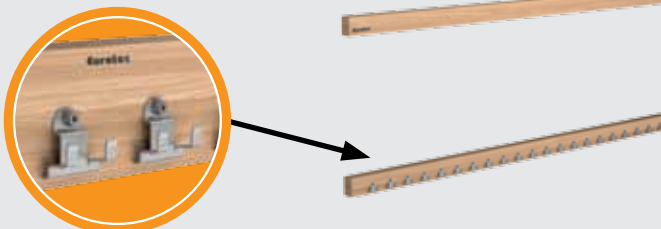

- 2** Façadeclips Rhombus Starter must also be installed to the end of each further substructure joist (right or left). These must be aligned along the substructure.

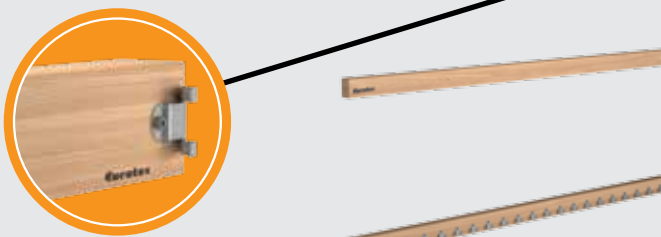

- 3** A slot has to be milled at the end of each board. This is placed on the first pre-assembled Façadeclip Rhombus Starter. Due to the laterally attached Façadeclips Rhombus Starter, the profile should already have a certain fixation on the wall. In order to optimise this, it is advisable to mount a Façadeclip Rhombus on one of the middle substructure profiles.

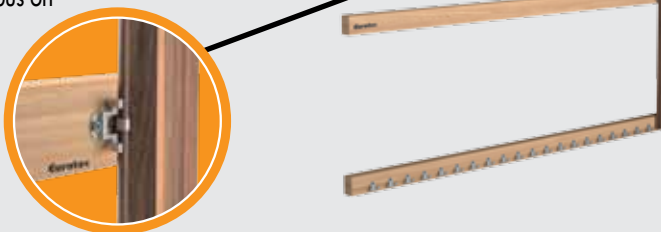

- 4** The remaining Façadeclips Rhombus can be mounted along the profile. Place the clips between the board and the substructure joist and fix them with the enclosed screw. The screws of all clips must be sufficiently tightened. The information provided as in the remark applies to fixed points in the event of horizontal installation.



The function can only be guaranteed when the specifications are complied with.

NEW
to our product range

Façade fixing screw ZK

Ornamental head, hardened stainless steel

Stainless Steel



Advantages

- Non-visible attachment
- Milling ribs enable easy countersinking for all types of wood
- Short thread for compact bolting to the substructure and the rhombus profile
- Corrosion-resistant up to and including service class 3 - "freely exposed constructions" according to DIN EN 1995 (Eurocode 5)

Application information

The particular screw geometry decreases the risk of splitting the wood. Pre-drilling, however, is strongly recommended, in particular for hardwoods used for the façade construction!

Assembly instructions for horizontal profile arrangement

- 1 Uniformly position the rhombus profiles.

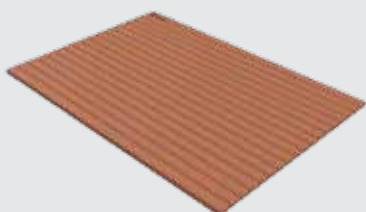

- 2 Uniformly position the substructure at right angles to the rhombus profiles.

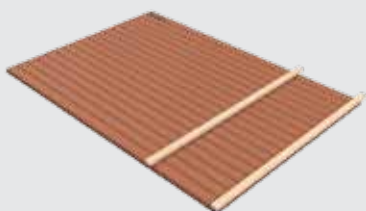

- 3 Bolt the lowest rhombus profile to the substructure using the ZK façade screws.

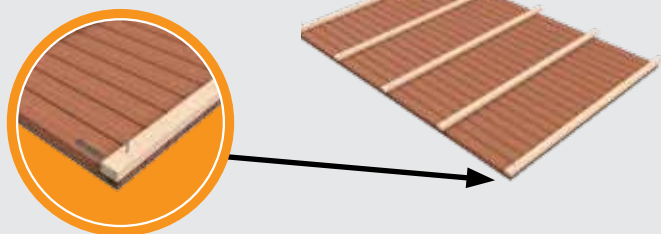

Façade fixing screw ZK

For the non-visible attachment of rhombus profiles

Art. no.	Dimensions [mm]	Drive	PU
905577	5,5 x 40	TX25 •	200
905578	5,5 x 45	TX25 •	200
905579	5,5 x 50	TX25 •	200
905580	5,5 x 55	TX25 •	200
905581	5,5 x 60	TX25 •	200
905582	5,5 x 70	TX25 •	200
905583	5,5 x 80	TX25 •	200
905585	5,5 x 90	TX25 •	200
905584	5,5 x 100	TX25 •	200

Profile

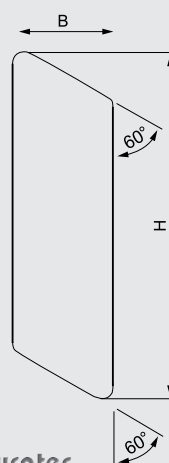

Wall-connection



- 4 Inspect the spacing to the next rhombus profile, bolt the profile to the substructure and repeat **step 4** until all profiles are fastened.

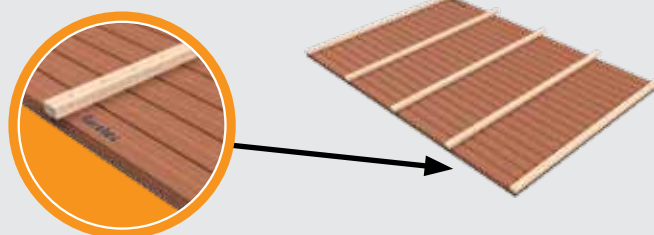

- 5 Install the wall element and mount it to the wall.

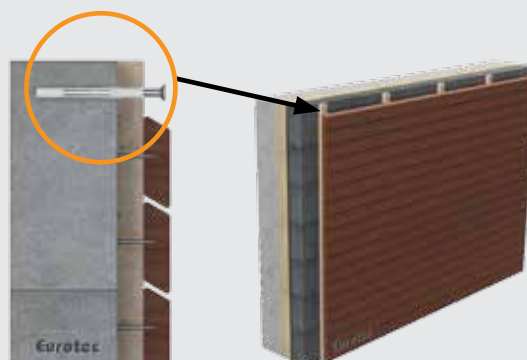

PediX post feet

Quick to assemble, with an especially high load-bearing capacity



What can it be used for?

- For anchoring wooden posts of wooden structures onto concrete foundations
- Carports, canopies, patio roofs

Advantages

- Easy assembly without milling
- Subsequently adjustable in height up to 50, 100 and 150 mm
- The PediX 300 + 150 and the PediX 300 + 150 HV enable the increased demands on constructive wood preservation according to DIN 68800-2
- High load capacity according to ETA 13/0550
- Additional constructive timber protection thanks to gasket on end grain
- Min. timber cross section of 100 x 100 mm
- Hot-dip galvanised structural steel S235JR (ST37-2)
- Meets the requirements of constructive wood preservation, thus increasing the longevity of the wood construction (protection against splashing water)

Installation

- Simple assembly with fully threaded screws and no need for joinery work, pilot-drilling or milling
- Comes supplied with 12 fully threaded A2 screws measuring 5,0 x 80 mm











Suitable for this:
Rock concrete screw hexagonal
BIM A2 10,5 x 95 mm
Art. no.: 110355





PediX post feet

Technical data

Name	Art. no.	Height adjustment in assembled state	Min. post cross section	Dimensions of baseplate	Compressive loadbearing capacity	Tensile loadbearing capacity	Lateral force resistance ¹⁾	PU
Post feet on concrete		[mm]	[mm]	H x L x W [mm]	N _{c,d} [kN]	N _{t,d} [kN]	V _{R,d} [kN]	pcs.
PediX 140+50 	904681	140 - 190	100 x 100	8 x 160 x 100	48,0	9,2	-	4
PediX 190+100 	904682	190 - 290	100 x 100	8 x 160 x 100	30,9	9,2	-	4
PediX 300+150 	904689	300 - 450	100 x 100	8 x 160 x 100	16,2	9,2	-	4
PediX 140+50 HV 	904681-HV	140 - 190	100 x 100	8 x 160 x 100	48,0	9,2	3,5	4
PediX 190+100 HV 	904682-HV	190 - 290	100 x 100	8 x 160 x 100	35,4	9,2	2,9	4
PediX 300+150 HV 	904689-HV	300 - 450	100 x 100	8 x 160 x 100	34,5	8,6	2,3	4
Post feet in concrete		Height adjustability [mm]	[mm]	H x L x W [mm]	N _{c,d} [kN]	N _{t,d} [kN]	V _{R,d} [kN]	pcs.
PediX B500 	904683	-	100 x 100	-	49,0	24	4,6	4
PediX B500+50 	904686	50	100 x 100	-	44,9	23	-	4

1) The lateral force resistance must be overlaid with the compressive and tensile load in accordance with ETA-13-/0550 and can therefore lead to lower load-bearing capacities.

Please note: The stated values are only intended as planning aids. They are subject to typographical and printing errors. Projects must only be calculated by authorised persons.

Installation instructions:

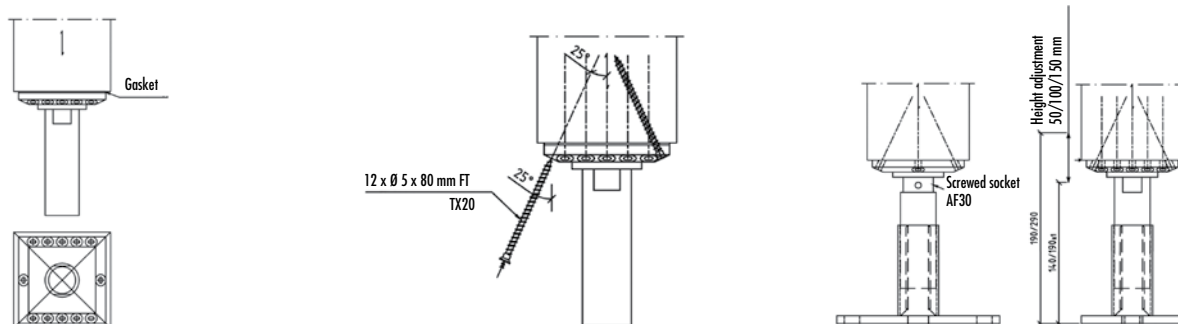
 You will find more-detailed information in our installation instructions

The PediX post foot can be attached easily to the end grain. Place the seal on the support foot and then place both parts centrally on the end grain surface.
Note: To make assembly easier, the base plate and the cover sleeve can be unscrewed.

After centering the head plate, screw in the 12 A2 full-thread 5,0 x 80 mm screws at an angle of 25° without base plate.

The protective sleeve and the pilot drilling can be reinstalled after all screws are fitted. After the post is erected with the post foot installed, it can be anchored on a concrete foundation with two or four cavity-wall ties or concrete bolts. Once the foot is installed on the socket, its height can be adjusted using an AF30 spanner.

Please note: Do not screw the post foot to a height greater than 190, 290 or 450 mm respectively.

PediX Easy 135+65 / 200+100

NEW
to our product range

PediX Easy 135+65 / 200+100



Advantages / Properties

- Simple assembly with fully threaded screws and no need for joinery work, pilot-drilling or milling
- Min. timber cross section of 100 x 100 mm
- Can be used in the usage classes 1, 2 and 3 in accordance with DIN EN 1995-1-1

Product description

The PediX Easy 135+65 and PediX Easy 200+100 are post supports for lightweight timber structures that meet structural wood preservation requirements. They can be assembled on the end grain without any need for additional joinery work or pilot drilling using fully threaded screws. Following assembly, the height of the support pedestals can still be adjusted by 65 mm or 100 mm. Thanks to the height adjustment, manufacturing tolerances relating to the structure and subsequent settlement in the individual foundations can be balanced out. The PediX Easy 135+65 and PediX Easy 200+100 can also absorb horizontal loads. The pedestal's durability is guaranteed by a zinc/nickel coating.

Art. no.	Name	Dimensions of baseplate [mm] ^{a)}	Height adjustment in assembled state	PU*
904678	PediX Easy 135+65	160 x 100 x 6	135 - 200	4
904684	PediX Easy 200+100	160 x 100 x 6	200 - 300	4

a) Length x width x height

*Delivery incl. twelve A2 fully threaded screws (Ø 5,0 x 80 mm) per post support

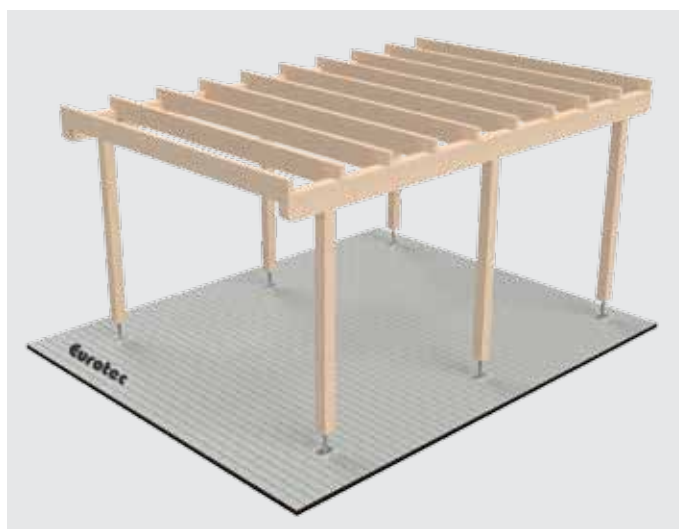
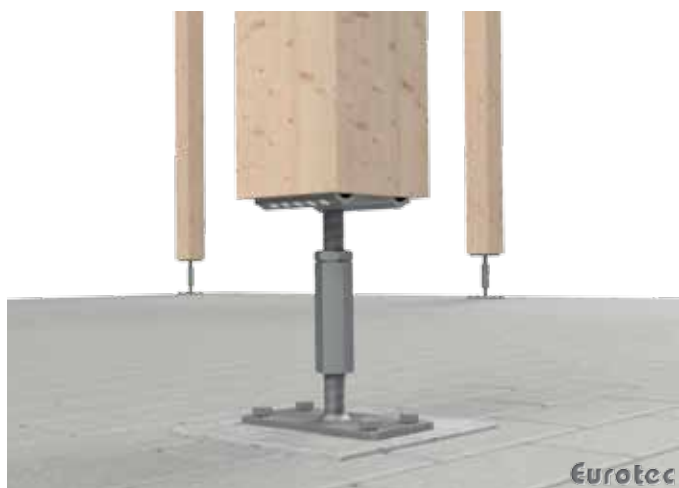

NEW
to our product range

PediX Duo 150+45 / 190+80

PediX Duo 150+45 / 190+80



Advantages / Properties

- Simple assembly with fully threaded screws and no need for joinery work, pilot-drilling or milling
- The bayonet lock makes assembling the support pedestal and the structure extremely easy
- Two-part structure
- Min. timber cross section of 100 x 100 mm
- Can be used in the usage classes 1, 2 and 3 in accordance with DIN EN 1995-1-1



Product description

The PediX Duo 150+45 and PediX Duo 190+80 are post supports for lightweight timber structures that meet structural wood preservation requirements. The pedestals' durability is guaranteed by a zinc/nickel coating. The post supports can be assembled on the support's end grain without any need for additional joinery work or pilot drilling using fully threaded screws. The bayonet lock permits extremely easy assembly of the top part with the assembled support and the anchored bottom part. The connection is locked by plugging in and pulling up the lock. The connection established in this way can even transfer tensile forces from the support to the foundation. Following assembly, the height of the support pedestal can still be adjusted by 45 mm or 80 mm.

If you have any further questions about assembly, please refer to our assembly instructions or contact our Application Engineering Department (Technik@eurotec.team)

Art. no.	Name	Dimensions of baseplate [mm] ^{a)}	Height adjustment in assembled state	PU*
904679	PediX Duo 150+45	160 x 100 x 8	150 - 195	4
904680	PediX Duo 190+80	160 x 100 x 8	190 - 270	4

a) Length x width x height

*Delivery incl. twelve A2 fully threaded screws (Ø 5,0 x 80 mm) per post support

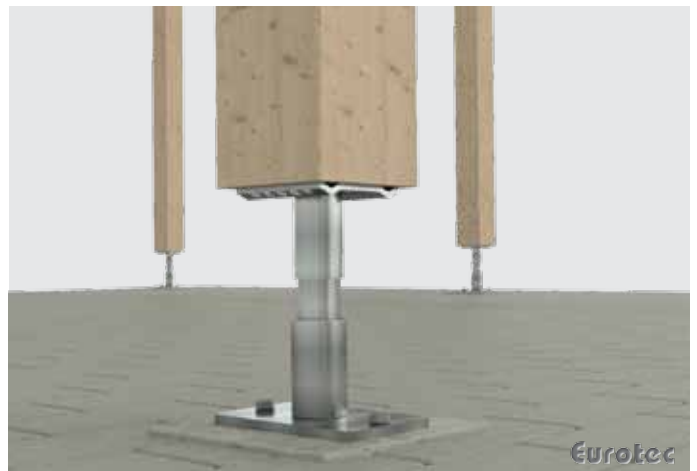

H post anchor, Fence post connection screw, Post cap, Hammer-in ground sockets

H post anchor

Hot-dip galvanised steel

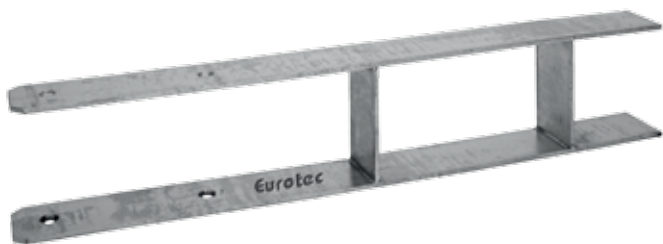

- For fixing square timber posts in place
- Fixed into concrete using H anchor
- Excellent corrosion protection thanks to hot-dip galvanisation

Art. no.	Fork width [mm]	Dimensions ^{a)} Overall/Post support [mm]	Drill holes ^{b)} Post support [mm]	PU
Material thickness: 6 mm				
904737	91	600 x 60 / 300	4 x 11	1
904738	101	600 x 60 / 300	4 x 11	1
904739	121	600 x 60 / 300	4 x 11	1
904740	141	600 x 60 / 300	4 x 11	1
Material thickness: 8 mm				
904741	161	800 x 60 / 400	4 x 11	1

a) Length x width / length
b) Number x Ø



Fence post connection screw

Specially coated

Suitable for this

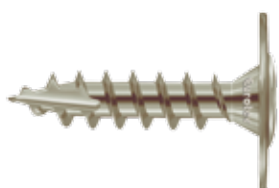

- Flange buttonhead screw Ø 8 mm
- Head diameter 22 mm
- Special tip geometry reduces the splitting effect, no pilot drilling required
- No pilot drilling required
- Special protection against corrosion
- Use, for example, in fence and pergola construction

Not suitable for wood containing tannins!

Fence post connection screw

A2

- Head diameter 22 mm

Stainless Steel



A2 stainless steel

- Limited resistance to acid
- Not suitable for atmospheres containing chlorine

Art. no.	Dimensions [mm]	Drive	PU
r903056	8 x 40	TX40 ●	100
r903057	8 x 50	TX40 ●	100
975594	10 x 40	TX40 ●	50
975595	10 x 50	TX40 ●	50

Art. no.	Dimensions [mm]	Drive	PU
975570	8 x 40	TX40 ●	100
975571	8 x 50	TX40 ●	100

Pyramid post cap

Hot-dip galvanised steel



- To protect posts against the effects of weathering
- Visual enhancement thanks to pyramid shape
- Excellent corrosion protection thanks to hot-dip galvanisation

Art. no.	Dimensions [mm]	PU
904733	71 x 71	1
904734	91 x 91	1
904735	101 x 101	1

Hammer-in ground socket

For square posts



- For fixing square timber posts in place
- Socket is fixed into the ground with ground anchors
- Excellent corrosion protection thanks to hot-dip galvanisation

Art. no.	Dimensions Post socket [mm] ^{a)}	Length Spike [mm]	Drill hole Post socket [mm] ^{b)}	PU
904703	150 x 71 x 71	750	4 x 11	1
904704	150 x 91 x 91	750	4 x 11	1
904730	150 x 101 x 101	750	4 x 11	1

a) Height x length x width
b) Number x Ø

Hammer-in ground socket

For round posts



- For fixing round timber posts into place
- Socket is fixed into the ground with ground anchors
- Excellent corrosion protection thanks to hot-dip galvanisation

Art. no.	Dimensions Post socket [mm] ^{a)}	Length Spike [mm]	Drill hole Post socket [mm] ^{b)}	PU
904705	81 x 150	450	4 x 11	1
904706	101 x 150	450	4 x 11	1
904707	121 x 145	605	4 x 11	1

a) Ø x Height
b) Number x Ø



Screw-on sockets, movable post holders

Hot-dip galvanised steel

Screw-on socket

For square posts



- For fixing square timber posts in place
- Socket is fastened to the subsurface with four screws
- Excellent corrosion protection thanks to hot-dip galvanisation

Art. no.	Dimensions Post socket [mm] ^{a)}	Dimensions Baseplate [mm] ^{b)}	Drill holes Bodenplatte/Post socket ^{c)}	PU
904695	150 x 71 x 71	150 x 150	4 x 11 / 4 x 11	1
904696	150 x 91 x 91	150 x 150	4 x 11 / 4 x 11	1
904697	150 x 101 x 101	150 x 150	4 x 11 / 4 x 11	1
904698	150 x 121 x 121	180 x 180	4 x 11 / 4 x 11	1
904736	150 x 141 x 141	200 x 200	4 x 11 / 4 x 11	1
904743	150 x 161 x 161	240 x 240	4 x 11 / 4 x 11	1
904747	150 x 181 x 181	280 x 280	4 x 11 / 4 x 11	1
904748	150 x 201 x 201	300 x 300	4 x 11 / 4 x 11	1

a) Height x length x width

b) Length x Width

c) Number x Ø

Screw-on socket

For round posts



- For fixing round timber posts into place
- Socket is fastened to the subsurface with four screws
- Excellent corrosion protection thanks to hot-dip galvanisation

Art. no.	Dimensions Post socket [mm] ^{a)}	Dimensions Baseplate [mm] ^{b)}	Drill holes Baseplate/Post socket ^{c)}	PU
904701	101 x 150	150 x 150	4 x 11 / 4 x 11	1
904702	121 x 147	180 x 180	4 x 11 / 4 x 11	1

a) Ø x height

b) Length x width

c) Number x Ø

Post holder

Movable, for round posts



- For fixing round timber posts into place
- Socket is fastened to the subsurface with four screws
- Movable upper section allows attachment to inclined subsurfaces
- Excellent corrosion protection thanks to hot-dip galvanisation

Art. no.	Dimensions Post socket [mm] ^{a)}	Dimensions Baseplate [mm] ^{b)}	Drill holes Baseplate/Post socket ^{c)}	PU
904713	101 x 150	140 x 130	4 x 11 / 3 x 5	1
904714	121 x 150	160 x 150	4 x 11 / 3 x 5	1

a) Ø x height

b) Length x width

c) Number x Ø

U post holder

Movable, for square posts



- For fixing square timber posts in place
- Socket is fastened to the subsurface with four screws
- Movable upper section allows attachment to inclined subsurfaces
- Excellent corrosion protection thanks to hot-dip galvanisation

Art. no.	Fork width [mm]	Length Post support [mm]	Dimensions Baseplate [mm] ^{a)}	Drill holes Baseplate/Post support [mm] ^{b)}	PU
904708	71	100	100 x 100	4 x 11 / 6 x 11	1
904709	91	100	100 x 100	4 x 11 / 6 x 11	1

a) Length x width

b) Number x Ø

U post holders, Corner connectors, U brackets

Hot-dip galvanised steel

U post holder



- For fixing square timber posts in place
- The bracket is fastened to the subsurface with three screws
- Post supports in sides provide spacing between the ground and the timber profile, aiding constructive timber protection
- Excellent corrosion protection thanks to hot-dip galvanisation

Art. no.	Fork width [mm]	Dimensions Post support [mm] ^{a)}	Drill holes Baseplate/Post support [mm] ^{b)}	PU
904717	71	150 x 60	2 x 11; 1 x 14 / 6 x 11	1
904719	91	150 x 60	2 x 11; 1 x 14 / 6 x 11	1
904721	101	150 x 60	2 x 11; 1 x 14 / 6 x 11	1

a) Length x width
b) Number x Ø

U post holder

With stone pin



- For fixing square timber posts in place
- The bracket is fixed in the concrete with a 200 m long stone pin
- Post supports in sides provide spacing between the ground and the timber profile, aiding constructive timber protection
- Excellent corrosion protection thanks to hot-dip galvanisation

Art. no.	Fork width [mm]	Dimensions Post support [mm] ^{a)}	Dimensions Stone pin [mm] ^{b)}	Drill holes Post support [mm] ^{c)}	PU
904716	71	150 x 60	16 x 200	6 x 11	1
904718	91	150 x 60	16 x 200	6 x 11	1
904720	101	150 x 60	16 x 200	6 x 11	1
904715	121	150 x 60	16 x 200	6 x 11	1

a) Length x width
b) Ø x height
c) Number x Ø

Corner connector

For square posts



- For fixing square timber posts in place
- The corner connectors are fastened to the base by four screws
- Ermöglichen eine variable Breitereinstellung
- Excellent corrosion protection thanks to hot-dip galvanisation

Art. no.	Dimensions Post socket [mm] ^{a)}	Dimensions Baseplate [mm] ^{b)}	Drill holes Baseplate/Post socket [mm] ^{c)}	PU
904710	200 x 105 x 105	82 x 155	2 x 11 / 6 x 11	1

a) Height x length x width
b) Length x width
c) Number x Ø

U bracket

For fences



- For fixing round timber posts into place
- Corrosion protection

Art. no.	Fork width [mm]	Dimensions [mm] ^{a)}	Drill holes Post support [mm] ^{b)}	PU
904711	101	233 x 40	4 x 6	1
904712	121	270 x 40	4 x 6	1

a) Length x width
b) Number x Ø

Post support 135 + 65

Steel, blue galvanised

Post support 135 + 65



Art. no.	Dimensions of baseplate [mm] ^{a)}	PU
904749	6 x 160 x 80	1

a) Height x width x length

Advantages and properties

- Simple assembly with fully threaded screws and no need for joinery work, pilot-drilling or milling
- Min. timber cross section of 100 x 100 mm
- After assembly, height adjustable up to 65 mm
- S235JR (ST37-2) structural steel, blue galvanised
- Can be used in the usage classes 1 and 2 in accordance with DIN EN 1995-1-1

Technical data: Post support 135 + 65

Name	Art. no.	Height adjustment in assembled state	Min. post cross section	Dimensions of baseplate	Compressive loadbearing capacity	Tensile load-bearing capacity	Lateral force resistance	PU
Post feet on concrete		[mm]	[mm]	L x W x H [mm]	$N_{c,d}$ [kN]	$N_{t,d}$ [kN]	$V_{R,d}$ [kN]	Pcs.
Post support 135 + 65	904749	135 - 200	100 x 100	6 x 160 x 80	40,0	6,1	0,8	1





Eurotec sales shelves

For showcasing products

The Minishop and the Midishop are cost-effective and space-saving alternatives for selling Eurotec deck products.

Minishop

- Supplied as a mini sales unit on a europallet
- Incl. model deck as an example application
- Individually stocked with Terrassotec or Hapatec screws, incl. in bucket

The shelf has the following dimensions:

Height 110 cm, width 74 cm, depth 60 cm

Display:

Height 70 cm, width 74 cm

Sales sample

Use the sales sample to present the advantages of the Distance strip 2.0 and deck glider systems quickly and understandably.



Perfectly presented, explained simply and understandably!

With Eurotec's shelves you receive terrace accessories in the most common dimensions and materials organised onto one shelf. This gives you the opportunity to equip your customers with just one shelf for everyday terrace construction.



Midishop

- Supplied as a midi sales unit on a europallet
- Incl. model deck as an example application
- Individually stocked with deck accessories such as Terrasotec, Rolfi, adjustable pedestals, deck gliders, bit sets, etc.

The shelf has the following dimensions:

Height 120 cm, width 118 cm, depth 60 cm

Display:

Height 70 cm, width 118 cm

We deliver everything you need to explain and present the Eurotec terrace products!

Eurotec Deck Shop

Everything at a glance

The practical and individually combinable display system for an attractive presentation of our products in your sales area.

Product presentation in a premium display system

- Wood construction or deck shop
- Single, double ... multiple unit
- We install and set up individually for you

Display example with 3 modules:

375 cm wide, 224 cm high, 65 cm deep;
individual module depth 125 cm



Perfectly presented, explained simply and understandably!



Conditions of sale and delivery

All sales to buyers, customers and contract partners, hereinafter referred to as customers, are made exclusively subject to the following terms and conditions unless other agreements are made in writing in the individual case:

1. Scope, general provisions

Our terms and conditions shall apply exclusively! We will not accept contradictory terms and conditions of our customers that deviate from our conditions unless we have given our express written consent to their validity. Our terms and conditions shall apply even if we execute orders without reservation despite being aware of contradictory conditions or conditions that deviate from our terms and conditions. Our terms and conditions shall also apply to all future transactions with our customers. Customers can access the latest version of these Standard Terms and Conditions at www.eurotec.team at any time.

2. Offers, written form

Our offers are non-binding and subject to alteration without notice until we issue our final order confirmation. Contracts and agreements, as well as transactions brokered by our representatives, shall become binding only when we issue our written order confirmation. Verbal agreements, even within the framework of contract execution, are not valid unless confirmed by us in writing.

3. Prices, packaging, offsetting

Unless otherwise indicated by the order confirmation, our prices are ex-works and exclusive of packaging. This is billed separately. The minimum order value is €50.00. For smaller quantities, we charge a flat processing fee of €30.00.

- Our prices are exclusive of statutory value added tax. This is stated and charged separately in the invoice at the statutory rate applicable on the date of billing.
- Our customer may only claim a right of offsetting insofar as counterclaims are established to be legally binding or are undisputed or accepted. A right of retention may only be exercised with respect to counterclaims resulting from the same contractual relationship.

4. Delivery, delivery period and force majeure

Unless otherwise agreed in writing, the place of performance shall be our company premises. The goods are shipped at the customer's risk and expense by third parties acting on our behalf. From the time at which the goods are made ready for delivery and the customer has been informed of their readiness for shipping, the customer shall bear the risk of accidental loss or deterioration of the item. This shall apply even if shipping is delayed as a result of circumstances for which we are not responsible. Punctual handing over of the goods to a shipping company requires that the order be placed on time by our customer. If the goods are handed over to the appointed shipping company punctually, we will not be liable for delayed delivery to the customer. This shall apply even if a delivery deadline was agreed with the customer, especially in the case of delivery to a construction site. The customer may be exempted from rush charges incurred in relation to this if there is a legal basis for deducting this surcharge from the forwarder's bill.

Statements relating to delivery periods are always to be seen only as approximate and non-binding. They shall begin on the date of our order confirmation but not before all of the order details are clarified in full. They refer to the time of consignment ex-works and shall be considered met when the goods are reported to be ready for dispatch. Without prejudice to our rights arising due to the customer's default, they shall be extended by the period for which the customer is in arrears to us with respect to their obligations arising from this or other orders.

Even if they arise at our suppliers, the following grounds are among those that shall release us from the obligation to adhere to the delivery period and shall entitle us to extend the delivery periods, to make partial deliveries or to wholly or partially withdraw from the part of the contract that is not yet fulfilled without becoming liable to pay damages as a result, unless we are guilty of intent or gross negligence: interruptions of operations and difficulties in delivery of any kind, e.g. shortages of machinery, goods, materials or fuels, or incidents of force majeure, e.g. export and import embargos, fires, strikes, lock-outs or new official measures that adversely affect production costs and shipping.

5. Shipping

Goods are shipped at the expense and risk of the customer even if prepaid delivery was agreed. Additional costs for express shipping shall always be borne by the customer. Freight costs paid by us are to be seen only as an advancement of freight charges on behalf of the customer. Additional freight costs for urgent and express parcels shall be borne by the customer, even if we have borne the transport costs on individual occasions. Goods reported as ready for shipping must be accepted immediately and will be charged as ex-works. If the goods are to be shipped abroad or passed directly to third parties, they must be examined and accepted in our factory; otherwise, the goods shall be deemed to have been delivered in accordance with the contract to the exclusion of any complaints. The risk, including that of confiscation, shall be transferred to the customer when the goods are handed over to the forwarder or freight carrier and, at the latest, when they leave our facility. Return shipments always require prior consultation with our internal sales department. Goods that are free of defects are only taken back with our express consent. A credit note is then issued for the value of the goods with deduction of a 25% return fee per item or against a minimum fee of €50 for returning the goods to storage. Strictly no debit notes are accepted.

6. Design and property rights

The customer shall bear sole responsibility and be liable for ensuring that the goods it orders do not violate third party property rights. No verification is performed on our part in this respect. The customer shall indemnify us against injunctions or claims for damages by third parties. If an injunction is requested against us, the customer shall meet the legal costs and shall compensate us for the damages we have incurred.

7. Acceptance, quantity tolerances and call-offs

For contracts with ongoing deliveries, the goods are to be accepted in monthly quantities that are as consistent as possible over the course of the contractual period. If a call-off is not made on time, we shall be entitled, after the expiry of a grace period that we have granted, to divide the order at our own discretion, withdraw from the part of the contract that has not yet been executed, or make a claim for damages due to non-performance. In the case of call-off orders, the call-offs must always be made within 12 calendar months. Over- or under-shipment by up to 10% of the order shall be permissible.

8.1 Payment terms for invoices, right of retention

Invoices shall be payable with a 2% discount within 10 days of the invoice date or net within 30 days, regardless of when the goods are received and without prejudice to the right to make a complaint for defects. Payment by means of acceptance or customer's bill of exchange shall require special written agreement in advance. Discount charges will be charged in the case of payment by means of acceptance, which must have a term no longer than 3 months and be issued within 1 week of the invoice date. Credit notes for bills of exchange or cheques shall apply subject to receipt and regardless of the purchase price's earlier due date in the event of default by the customer. They shall be issued with the value at the date on which the equivalent amount will be available to us; the discount charges will be charged at the respective bank rate. In the event that the payment term is exceeded, interest and commissions may be charged without prejudice to other rights at the respective bank rate for overdrafts but at a rate at least 5% above the respective discount rate of the Deutsche Bundesbank [German Federal Bank]. If the payment terms are not adhered to or we become aware of circumstances that, in our view, are sufficient to reduce the customer's credit worthiness, all of our claims shall become payable immediately regardless of the term of any bills of exchange that have been accepted or credited.

We shall then also be entitled to perform outstanding deliveries only in exchange for advance payment, to withdraw from the contract after a reasonable grace period, and to demand compensation for default. We may also prohibit the resale or processing of the delivered goods and demand their return or the transfer of indirect possession of the delivered goods at the customer's expense. The customer hereby already authorises us to enter its premises and confiscate the delivered goods in the above cases. We shall be entitled to the usual securities for our claims according

to their nature and extent, even if they are subject to conditions or of limited duration. Offsetting or withholding payments as a result of any counterclaims or notifications of defects shall be prohibited, except where claims are undisputed or established to be legally binding.

8.2 Terms of payment for web-shop customers

Payment shall be made exclusively in advance. Once the order process in our online shop is complete, you will receive an email with the bank details for our business account. The invoiced amount must be transferred to our account within 7 days. We cannot carry out your order until the payment arrives.

9. Retention of title

Until all liabilities arising from the business relationship are paid in full and, in particular, until all bills of exchange and cheques, including finance bills, given as payment are cashed, the goods delivered by us shall remain our property and may be taken back by us at the customer's expense in the event of default in payment. Until this point, the customer shall not be entitled to pledge or assign the goods to third parties as a security; it may sell them on or process them only within the framework of its ongoing business transactions. The customer shall be obliged to inform us immediately of any seizure by third parties of the goods delivered subject to retention of title.

In the event of further processing, the customer shall not acquire ownership of the goods delivered by us as set out in section 950 of the German Civil Code (BGB), as any processing is carried out by the customer on our behalf. Without prejudice to the rights of third-party suppliers, the newly created thing shall serve as security for us up to the amount of our total claims arising from the business relationship. It shall be kept safe for us by the customer and shall be regarded as goods for the purpose of these terms and conditions. If the item is intermixed or otherwise combined with other objects that do not belong to us, we shall acquire at least co-ownership of the new thing in proportion to the value of the contract item to that of other objects that have been processed with it. If the customer sells the goods delivered by us, regardless of their condition, it hereby already assigns to us all claims against its customers arising from sales, as well as all ancillary rights, until all of our claims arising from delivery of goods are paid in full. At our request, the customer shall be obliged to notify its downstream customers of the assignment and to hand over the information and documents we require in order to assert our rights against its downstream customers.

If the total value of the securities given to us exceeds our claims arising from delivery by more than 20%, we shall be obliged to retransfer securities to this extent at the customer's request. If the retention of title or assignment is invalid in the territory in which the goods are located, a security corresponding to the retention of title or assignment in this territory shall be deemed to be agreed. If the customer's cooperation is required in this process, it shall take all necessary measures to establish such rights.

10. Notification of defects, liability

Our customer shall be entitled to a warranty only if they have properly fulfilled their legal obligations under sections 377 and 378 of the German Commercial Code (HGB) with respect to the duties of examination and notification. If defects are present, we shall be entitled at our choice to either repair the defects or provide a replacement; if we are not prepared or not able to do so, and especially if repair/replacement is delayed beyond reasonable deadlines for reasons that we are responsible for, or if repair/replacement otherwise fails, our customer shall be entitled at its choice to withdraw from the contract or to demand a corresponding reduction in the price.

Unless otherwise stipulated below, further claims of the customer shall be excluded regardless of their legal basis. We shall not be liable for damage that did not occur to the delivered item itself. In particular, we shall not be liable for lost profit or other pecuniary losses of the customer. The above exemption from liability shall not apply if the damage is caused by intent or gross negligence; it shall also not apply if the customer asserts claims for damages for non-performance due to the lack of a warranted characteristic. If we breach an essential contractual duty through negligence, our duty of reimbursement for property damage or personal injury shall be restricted to the level of cover provided by our product liability insurance.

We are prepared to allow the customer to view our policy. The warranty period is 6 months calculated from the date of transfer of risk. This period is a limitation period. The period shall also apply to claims under sections 1 and 4 of the German Product Liability Act (ProdHaftG). Insofar as our liability is excluded or restricted, this shall also apply to the personal liability of our employees, workers, staff, representatives and agents. Goods that are subject to a complaint must not be sent back without obtaining our prior written consent, as otherwise we may refuse to accept them at the sender's expense. Goods that have been partially or wholly processed will not be taken back under any circumstances.

The customer is obliged to make sure that the purchased product is suitable for the intended application using technical descriptions, where available, and based on their specialist knowledge and to familiarise themselves with the application of this product. If they are not familiar with the product's application, our company staff are available to provide advice. All information and advice from our staff is provided carefully and conscientiously.

Under no circumstances does this information and advice replace the indispensable consultancy services of architects and specialist planning companies or the services they provide during construction. Only the authorised professional groups are entitled to provide these services.

11. Place of performance and jurisdiction, miscellaneous

Our company's registered office shall be the place of performance for all obligations arising from this contract, including liabilities from cheques and bills of exchange. Provided our customer is a merchant, the place of jurisdiction for all disputes arising from the contractual relationship shall be, at our choice, the Local Court of Hagen.

Contracts with our customer shall be governed exclusively by German law to the exclusion of the UN Convention on Contracts for the International Sale of Goods of 11 April 1980. The language of the contract shall be German.

Hagen, 16 February 2018

E.u.r.o.Tec GmbH · Unter dem Hofe 5 · 58099 Hagen
 Managing directors: Markus Rensburg, Gregor Mamys
 Court of registration: Local Court of Hagen Registration number: HRB 3817
 VAT ID No.: DE 812674291
 Tax number: 321/5770/0639

Tel. +49 2331 62 45-0 · Fax +49 2331 62 45-200 · E-Mail info@eurotec.team · www.eurotec.team

Index

A	Adapter	34	I	Inside corner deck edging set	63
	Adjustable pedestals	4 - 5, 28 - 33	L	L adapter	32
	Aluminium concrete bracket NEW	52		Level Mate	37
	Aluminium cover	66		Long-bit 50X	82
	Aluminium Deck Support System HKP	54 - 55	M	Magnet Bit Set	102
	Aluminium eaves	67		Magnet TX Long Bit	102
	Aluminium function strip	58		Mammutec	99
	Aluminium profile drilling screw	47		Material requirements planning	19 - 21
	Aluminium support-profile connector	56		MaTre band	49
	Angled screwing attachment	101	N	Nivello 2.0	33
B	BASE-Line adjustable pedestals NEW	29 - 30	O	Overview of timber types	10 - 16
	BiGHTY drilling screw	56	P	Patios	20, 26 - 27
	Bit-Box	101		PediX Duo 150+45/190+80 NEW	115
	Bit dispenser box	100		PediX Easy 135+65/200+100 NEW	114
	Bit holder	100		PediX post feet	112 - 113
C	Click adapter	32		Post holder	116 - 119
	Cork	23, 58 - 59		Post support 135 + 65	120
	Cork pad spacer	23		Protectus, timber-protection tape	24
	Cork pad with adhesive tape	59		Profile connector deck edging set	63
	Compensation disk	35		Profile drilling screw	88
	Corner connector	119		Profi-Line adjustable pedestals	31 - 32
	Corner connector deck edging set	63		Pyramid post cap	117
	Cover profile	69	Q	Quattro Lager	34
D	Deck fascia board mount	68	R	Ratchet screwdriver 12in1	102
	Deck gliders	76 - 77		Robusto deck pedestal	38 - 39
	Decking multi angles	78		Rolfi, spacers	24
	Deck screw 50X	82		Rolfi roll	25
	Deck substructure	6 - 7, 22 - 23, 54 - 55		Roof-protection cork	23
	DiLo aluminium function strip	58		Root control fleece underlay	24
	DiLo drilling screw	59	S	Screw-on socket	118
	Distance strip 2.0 NEW	86 - 87		Screw Stop	105
	DrainTec – aluminium drainage grate	70		Selecting screw steels for their corrosion resistance	8
	DrainTec Base	71		Shearing	87
	DrainTec Clip	70		Slab supports	34
	Drill Tool 50X	81		SL PRO adjustable pedestals	33
	Drill-Stop	105		Spacers	104
	Drill-Stop for Profile drilling screw NEW	105		Stainless steel Long Bit	102
E	ECO system clip	75		StarterClip	79
	ECO system connector	50		Step drill 50X	82
	End profiles for aluminium substructure	64		Stone adapter	32
	End profiles for single point support	62		Stone-Edge-Clip	47
	Eurotec Basic Shop	83, 93		Stone slab lifter	35
	Eurotec sales shelves	122 - 125		Stone slab spacer	35
	Evenco aluminium system profile	50		Stone System	26 - 27, 47
	Evenco corner connector	50		Support-profile HKP	55
	EVO aluminium system profile connector	43		Surface for adjustable feet	4 - 5
	EVO corner connector	43	T	Tenax spacer	104
	EVO/EVO Black Edition aluminium system profile	42		Tension clamp	104
	EVO joints	45		Terrace end profiles	60 - 71
	EVO Light system clip	74		Terrassotec	89 - 91
	EVO Light system connector	48		Terrassotec Trilobular	89 - 90
	EVO Light aluminium system profile	48		Thermofix screw	77
	EVO position anchor	44		Timber decks	7, 9 - 10, 19, 92
	EVO Slim aluminium system profile	46		Tri-Deck-Tec	92
	EVO Slim aluminium system profile connector	46		T-Stick	80
	EVO wall-connection bracket	44	U	Twin system clip	73
	Extension rings	32		U bracket	119
	External corner deck edging set	63		U post holder	119
F	Façadeclip	107	V	Visible fastening NEW	42, 58, 85 - 88
	Façadeclip for Rhombus profiles	108 - 110		V-Clip	84
	Façade fixing screw ZK	111	W	Wing-tipped profile drilling screw	88
	Fascia profile HKP	55			
	Fence post connection screw	116			
	Flex-Stone-Clip	47			
G	Glider screw	77			
H	Hammer-in ground socket	117			
	Hapatec screws	94 - 95			
	Hidden fastening	42, 58, 72 - 84			
	Hobotec screws	96 - 98			
	H post anchor	116			

More than
20
YEARS
of quality

www.eurotec.team/en

E.u.r.o.Tec GmbH
Unter dem Hofe 5 · D-58099 Hagen · Germany
Tel. +49 2331 62 45-0 · Fax +49 2331 62 45-200
Email info@eurotec.team

Publisher: E.u.r.o.Tec GmbH - Revised 09/2020
The content is subject to errors and technical changes and additions. All dimensions are approximate values.
The information is subject to modification and colour deviations, as well as errors.
We accept no liability for printing errors. Reprinting (even in part) is only permitted with E.u.r.o.Tec GmbH's prior approval.
Pictures cover page: © Photography by Kawasumi Kobayashi Keiji Photograph Office